

VERKEHRSZEICHEN

40

Verkehrszeichen	Seite 20
Vor- und Tabellenwegweiser	Seite 73
Brandschutzschilder Aluminium	Seite 74
Kunststoffschilder	Seite 74
Anti-Graffiti-Schutzfilm	Seite 75
Zusatzschilder mit Rand für Beschriftung mit Sondertexten	Seite 77
Klappschilder mechanisch / Prismenschilder	Seite 82
Windkraftanlagen	Seite 83
Verkehrsleitsäule	Seite 86
Kilometertafeln / Stationierungszeichen, Sonderschilder „Reißverschlussystem“	Seite 87
Folienbuchstaben	Seite 88
Folienpiktogramme	Seite 89
Folienschilder, selbstklebende, reflektierende	Seite 90
Folien	Seite 91

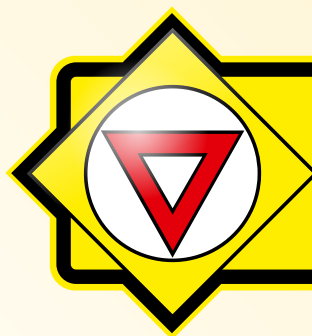











2 | VERKEHRSSZEICHEN

Nr.	Zeichen	Bedeutung	Maße in mm	Flachform 2 mm			Flachform 3 mm			Rundform			Alform		
				Folie RA1	Folie RA2	Folie RA3	Folie RA1	Folie RA2	Folie RA3	Folie RA1	Folie RA2	Folie RA3	Folie RA1	Folie RA2	Folie RA3
101		Gefahrstelle	SL 630 SL 900 SL 1260	29,00 43,00 -	39,00 62,00 -	47,00 78,00 -	38,00 65,00 120,00	51,00 91,00 165,00	59,00 105,00 193,00	75,00 75,00 190,00	77,00 80,00 202,00	83,00 93,00 225,00	58,00 83,00 190,00	63,00 92,00 213,00	71,00 108,00 250,00
101-10		Flugbetrieb, Aufstellung rechts	SL 900 SL 1260	43,00 -	62,00 -	78,00 -	65,00 120,00	91,00 165,00	105,00 193,00	75,00 190,00	80,00 202,00	93,00 225,00	83,00 190,00	92,00 213,00	108,00 250,00
101-20		Flugbetrieb, Aufstellung links	SL 900 SL 1260												
101-11		Fußgängerüberweg, Aufstellung rechts	SL 630 SL 900												
101-21		Fußgängerüberweg, Aufstellung links	SL 630 SL 900												
101-12		Viehtrieb, Aufstellung rechts	SL 630 SL 900												
101-22		Viehtrieb, Aufstellung links	SL 630 SL 900												
101-13		Reiter, Aufstellung rechts	SL 630 SL 900	29,00 43,00	39,00 62,00	47,00 78,00	38,00 65,00	51,00 91,00	59,00 105,00	75,00 75,00	77,00 80,00	83,00 93,00	58,00 83,00	63,00 92,00	71,00 108,00
101-23		Reiter, Aufstellung links	SL 630 SL 900												
101-14		Amphibien- wanderung, Aufstellung rechts	SL 630 SL 900												
101-24		Amphibien- wanderung, Aufstellung links	SL 630 SL 900												
101-15		Steinschlag, Aufstellung rechts	SL 630 SL 900 SL 1260												
101-25		Steinschlag, Aufstellung links	SL 630 SL 900 SL 1260	29,00 43,00 -	39,00 62,00 -	47,00 78,00 -	38,00 65,00 120,00	51,00 91,00 165,00	59,00 105,00 193,00	75,00 75,00 190,00	77,00 80,00 202,00	83,00 93,00 225,00	58,00 83,00 190,00	63,00 92,00 213,00	71,00 108,00 250,00
101-51		Schnee- oder Eisglätte	SL 630 SL 900 SL 1260												
101-52		Splitt, Schotter	SL 630 SL 900 SL 1260												
101-53		Ufer	SL 630 SL 900	29,00 43,00	39,00 62,00	47,00 78,00	38,00 65,00	51,00 91,00	59,00 105,00	75,00 75,00	77,00 80,00	83,00 93,00	58,00 83,00	63,00 92,00	71,00 108,00

Nr.	Zeichen	Bedeutung	Maße in mm	Flachform 2 mm			Flachform 3 mm			Rundform			Alform			
				Folie RA1	Folie RA2	Folie RA3	Folie RA1	Folie RA2	Folie RA3	Folie RA1	Folie RA2	Folie RA3	Folie RA1	Folie RA2	Folie RA3	
101-54		unzureichendes Lichttraumprofil	SL 630 SL 900													
101-55		bewegliche Brücke	SL 630 SL 900	29,00 43,00	39,00 62,00	47,00 78,00	38,00 65,00	51,00 91,00	59,00 105,00	75,00 75,00	77,00 80,00	83,00 93,00	58,00 83,00	63,00 92,00	71,00 108,00	
102		Kreuzung oder Einmündung	SL 630 SL 900													
103-10		Kurve links	SL 630 SL 900 SL 1260													
103-20		Kurve rechts	SL 630 SL 900 SL 1260													
105-10		Doppelkurve, zunächst links	SL 630 SL 900 SL 1260													
105-20		Doppelkurve, zunächst rechts	SL 630 SL 900 SL 1260													
108-..*)		Gefälle ... %	SL 630 SL 900 SL 1260													
110-..*)		Steigung ... %	SL 630 SL 900 SL 1260													
				<p>* Unternummer steht jeweils für den Zahlenwert (4 bis 25):</p> <p>Zum Beispiel: Zeichen 108-10 = 10 % Gefälle Zeichen 110-12 = 12 % Steigung</p>												
112		Unebene Fahrbahn	SL 630 SL 900 SL 1260	29,00 43,00 -	39,00 62,00 -	47,00 78,00 -	38,00 65,00 120,00	51,00 91,00 165,00	59,00 105,00 193,00	75,00 75,00 190,00	77,00 80,00 202,00	83,00 93,00 225,00	58,00 83,00 190,00	63,00 92,00 213,00	71,00 108,00 250,00	
114		Schleuder- oder Rutschgefahr	SL 630 SL 900 SL 1260													
117-10		Seitenwind von rechts	SL 630 SL 900 SL 1260													
117-20		Seitenwind von links	SL 630 SL 900 SL 1260													
120		Verengte Fahrbahn	SL 630 SL 900 SL 1260													
121-10		Einseitig verengte Fahrbahn, Verengung rechts	SL 630 SL 900 SL 1260													
121-20		Einseitig verengte Fahrbahn, Verengung links	SL 630 SL 900 SL 1260													

















VERKEHRSZEICHEN

Nr.	Zeichen	Bedeutung	Maße in mm	Flachform 2 mm			Flachform 3 mm			Rundform			Alform		
				Folie RA1	Folie RA2	Folie RA3	Folie RA1	Folie RA2	Folie RA3	Folie RA1	Folie RA2	Folie RA3	Folie RA1	Folie RA2	Folie RA3
123		Arbeitsstelle	SL 630 SL 900 SL 1260												
124		Stau	SL 630 SL 900 SL 1260	29,00 43,00 -	39,00 62,00 -	47,00 78,00 -	38,00 65,00 120,00	51,00 91,00 165,00	59,00 105,00 193,00	75,00 75,00 190,00	77,00 80,00 202,00	83,00 93,00 225,00	58,00 83,00 190,00	63,00 92,00 213,00	71,00 108,00 250,00
125		Gegenverkehr	SL 630 SL 900 SL 1260												
131		Lichtzeichenanlage	SL 630 SL 900 SL 1260												
133-10		Fußgänger, Aufstellung rechts	SL 630 SL 900												
133-20		Fußgänger, Aufstellung links	SL 630 SL 900												
136-10		Kinder, Aufstellung rechts	SL 630 SL 900												
136-20		Kinder, Aufstellung links	SL 630 SL 900	29,00 43,00	39,00 62,00	47,00 78,00	38,00 65,00	51,00 91,00	59,00 105,00	75,00 75,00	77,00 80,00	83,00 93,00	58,00 83,00	63,00 92,00	71,00 108,00
138-10		Radverkehr, Aufstellung rechts	SL 630 SL 900												
138-20		Radverkehr, Aufstellung links	SL 630 SL 900												
142-10		Wildwechsel, Aufstellung rechts	SL 630 SL 900 SL 1260	29,00 43,00 -	39,00 62,00 -	47,00 78,00 -	38,00 65,00 120,00	51,00 91,00 165,00	59,00 105,00 193,00	75,00 75,00 190,00	77,00 80,00 202,00	83,00 93,00 225,00	58,00 83,00 190,00	63,00 92,00 213,00	71,00 108,00 250,00
142-20		Wildwechsel, Aufstellung links	SL 630 SL 900 SL 1260												
151		Bahnübergang	SL 630 SL 900	29,00 43,00	39,00 62,00	47,00 78,00	38,00 65,00	51,00 91,00	59,00 105,00	75,00 75,00	77,00 80,00	83,00 93,00	58,00 83,00	63,00 92,00	71,00 108,00
156-10		Bahnübergang mit dreistreifiger Bake, Aufstellung rechts	SL 630/ 1000 x 300	75,00	101,00	122,00	98,00	130,00	151,00	146,00	154,00	170,00	170,00	183,00	208,00
			SL 900/ 1000 x 300	89,00	124,00	153,00	125,00	170,00	197,00	146,00	157,00	180,00	195,00	212,00	245,00
156-11		Bahnübergang mit dreistreifiger Bake, mit Entfernungs- angabe – Aufstellung rechts	SL 630/ 1000 x 300 SL 900/ 1000 x 300	75,00 89,00	101,00 124,00	122,00 153,00	98,00 125,00	130,00 170,00	151,00 197,00	146,00 146,00	154,00 157,00	170,00 180,00	170,00 195,00	183,00 212,00	208,00 245,00

Nr.	Zeichen	Bedeutung	Maße in mm	Flachform 2 mm			Flachform 3 mm			Rundform			Alform		
				Folie RA1	Folie RA2	Folie RA3	Folie RA1	Folie RA2	Folie RA3	Folie RA1	Folie RA2	Folie RA3	Folie RA1	Folie RA2	Folie RA3
156-20		Bahnübergang mit dreistreifiger Bake, Aufstellung links	SL 630/1000 x 300	75,00	101,00	122,00	98,00	130,00	151,00	146,00	154,00	170,00	170,00	183,00	208,00
			SL 900/1000 x 300	89,00	124,00	153,00	125,00	170,00	197,00	146,00	157,00	180,00	195,00	212,00	245,00
156-21		Bahnübergang mit dreistreifiger Bake, mit Entfernungsangabe – Aufstellung links	SL 630/1000 x 300	75,00	101,00	122,00	98,00	130,00	151,00	146,00	154,00	170,00	170,00	183,00	208,00
			SL 900/1000 x 300	89,00	124,00	153,00	125,00	170,00	197,00	146,00	157,00	180,00	195,00	212,00	245,00
157-10		dreistreifige Bake, Aufstellung rechts	1000 x 300												
157-11		dreistreifige Bake mit Entfernungsangabe Aufstellung rechts	1000 x 300												
157-20		dreistreifige Bake, Aufstellung links	1000 x 300												
157-21		dreistreifige Bake mit Entfernungsangabe Aufstellung links	1000 x 300												
159-10		zweistreifige Bake, Aufstellung rechts	1000 x 300												
159-11		zweistreifige Bake mit Entfernungsangabe Aufstellung rechts	1000 x 300	46,00	62,00	75,00	60,00	79,00	92,00	71,00	77,00	87,00	112,00	120,00	137,00
159-20		zweistreifige Bake, Aufstellung links	1000 x 300												
159-21		zweistreifige Bake mit Entfernungsangabe Aufstellung links	1000 x 300												
162-10		Einstreifige Bake, Aufstellung rechts	1000 x 300												
162-11		einstreifige Bake mit Entfernungsangabe Aufstellung rechts	1000 x 300												
162-20		Einstreifige Bake, Aufstellung links	1000 x 300												
162-21		einstreifige Bake mit Entfernungsangabe Aufstellung links	1000 x 300												
201-50		Andreas Kreuz stehend	1350 x 180 abgekantet	-	-	-	100,00	139,00	180,00	-	-	-	-	-	-

VERKEHRSZEICHEN

Nr.	Zeichen	Bedeutung	Maße in mm	Flachform 2 mm			Flachform 3 mm			Rundform			Alform		
				Folie RA1	Folie RA2	Folie RA3	Folie RA1	Folie RA2	Folie RA3	Folie RA1	Folie RA2	Folie RA3	Folie RA1	Folie RA2	Folie RA3
201-52		Andreaskreuz liegend	180 x 1350 abgekantet												
201-51		Andreaskreuz stehend, mit Blitzpfeil	1350 x 180 abgekantet	-	-	-	100,00	139,00	180,00	-	-	-	-	-	-
201-53		Andreaskreuz liegend, mit Blitzpfeil	180 x 1350 abgekantet												
205		Vorfahrt gewähren.	SL 630	29,00	39,00	47,00	38,00	51,00	59,00	75,00	77,00	83,00	58,00	63,00	71,00
			SL 900	43,00	62,00	78,00	65,00	91,00	105,00	75,00	80,00	93,00	83,00	92,00	108,00
			SL 1260	-	-	-	120,00	165,00	193,00	190,00	202,00	225,00	190,00	213,00	250,00
206		Halt. Vorfahrt gewähren.	900 x 900	100,00	147,00	183,00	135,00	190,00	227,00	142,00	157,00	189,00	169,00	189,00	228,00
			1050 x 1050	-	-	-	187,00	254,00	304,00	-	-	-	271,00	304,00	369,00
				In 2 mm Flachform nur für die Aufstellung im Rohrrahmen zulässig.											
208		Vorrang des Gegenverkehrs	Ø 420 Ø 600	28,00 39,00	41,00 58,00	49,00 74,00	40,00 67,00	54,00 94,00	63,00 109,00	56,00 66,00	62,00 71,00	67,00 84,00	53,00 72,00	58,00 81,00	67,00 97,00
209		Vorgeschriebene Fahrtrichtung rechts	Ø 420 Ø 600 Ø 750												
209-10		Vorgeschriebene Fahrtrichtung links	Ø 420 Ø 600 Ø 750												
209-30		Vorgeschriebene Fahrtrichtung geradeaus	Ø 420 Ø 600 Ø 750												
211		Vorgeschriebene Fahrtrichtung hier rechts	Ø 420 Ø 600 Ø 750												
211-10		Vorgeschriebene Fahrtrichtung hier links	Ø 420 Ø 600 Ø 750	28,00 39,00 78,00	41,00 58,00 107,00	49,00 74,00 132,00	40,00 67,00 105,00	54,00 94,00 137,00	63,00 109,00 164,00	56,00 66,00 108,00	62,00 71,00 117,00	67,00 84,00 139,00	53,00 72,00 148,00	58,00 81,00 160,00	67,00 97,00 196,00
214		Vorgeschriebene Fahrtrichtung geradeaus oder rechts	Ø 420 Ø 600 Ø 750												
214-10		Vorgeschriebene Fahrtrichtung geradeaus oder links	Ø 420 Ø 600 Ø 750												
214-30		Vorgeschriebene Fahrtrichtung rechts oder links	Ø 420 Ø 600 Ø 750												
215		Kreisverkehr	Ø 420 Ø 600 Ø 750												

Nr.	Zeichen	Bedeutung	Maße in mm	Flachform 2 mm			Flachform 3 mm			Rundform			Alform		
				Folie RA1	Folie RA2	Folie RA3	Folie RA1	Folie RA2	Folie RA3	Folie RA1	Folie RA2	Folie RA3	Folie RA1	Folie RA2	Folie RA3
220-10		Einbahnstraße linksweisend	300 x 800	38,00	52,00	62,00	49,00	66,00	76,00	63,00	67,00	75,00	70,00	76,00	87,00
220-20		Einbahnstraße rechtsweisend	300 x 800												
220-40		Einbahnstraße doppelseitig (-10/-20)	300 x 800	50,00	74,00	95,00	63,00	89,00	110,00	-	-	-	-	-	-
222		Vorgeschriebene Vorbeifahrt rechts vorbei	Ø 420 Ø 600 Ø 750	28,00 39,00 78,00	41,00 58,00 107,00	49,00 74,00 132,00	40,00 67,00 105,00	54,00 94,00 137,00	63,00 109,00 164,00	56,00 66,00 108,00	62,00 71,00 117,00	67,00 84,00 139,00	53,00 72,00 148,00	58,00 81,00 160,00	67,00 97,00 196,00
222-10		Vorgeschriebene Vorbeifahrt links vorbei	Ø 420 Ø 600 Ø 750												
223.1-50		Seitenstreifen befahren, 2 Fahrstreifen + Seitenstreifen	2250 x 2250												
223.1-51		Seitenstreifen befahren, 3 Fahrstreifen + Seitenstreifen	2250 x 2250												
223.1-52		Seitenstreifen befahren, 4 Fahrstreifen + Seitenstreifen	2250 x 2250												
223.2-50		Seitenstreifen nicht mehr befahren, 2 Fahrstreifen + Seitenstreifen	2250 x 2250												
223.2-51		Seitenstreifen nicht mehr befahren, 3 Fahrstreifen + Seitenstreifen	2250 x 2250												
223.2-52		Seitenstreifen nicht mehr befahren, 4 Fahrstreifen + Seitenstreifen	2250 x 2250												
223.3-50		Seitenstreifen räumen, 2 Fahrstreifen + Seitenstreifen	2250 x 2250												
223.3-51		Seitenstreifen räumen, 3 Fahrstreifen + Seitenstreifen	2250 x 2250												
223.3-52		Seitenstreifen räumen, 4 Fahrstreifen + Seitenstreifen	2250 x 2250												
224		Haltestelle	Ø 420	28,00	41,00	49,00	40,00	54,00	63,00	56,00	62,00	67,00	53,00	58,00	67,00
224-40		Haltestelle doppelseitig	Ø 420	34,00	53,00	68,00	47,00	67,00	83,00	-	-	-	-	-	-

Preise auf Anfrage

















VERKEHRSZEICHEN

Nr.	Zeichen	Bedeutung	Maße in mm	Flachform 2 mm			Flachform 3 mm			Rundform			Alform		
				Folie RA1	Folie RA2	Folie RA3	Folie RA1	Folie RA2	Folie RA3	Folie RA1	Folie RA2	Folie RA3	Folie RA1	Folie RA2	Folie RA3
224-51		Schulbushaltestelle (mit Zz 1042-36)	900 x 600	85,00	123,00	154,00	120,00	167,00	197,00	135,00	147,00	171,00	147,00	170,00	202,00
224-41		Schulbushaltestelle (mit Zz 1042-36) (doppelseitig)	900 x 600	111,00	172,00	234,00	147,00	217,00	279,00	-	-	-	-	-	-
229		Taxi	630 x 420 900 x 600	43,00 68,00	57,00 98,00	69,00 123,00	55,00 96,00	73,00 133,00	84,00 158,00	70,00 108,00	73,00 118,00	82,00 137,00	77,00 118,00	83,00 136,00	94,00 162,00
229-10		Taxi Aufstellung rechts	630 x 420 900 x 600												
229-20		Taxi Aufstellung rechts	630 x 420 900 x 600	Gestanzte Folien-Pfeile einzeln für Zeichen 229-10, -20, -30, -11, -21, -31: für 630 x 420 mm: RA 1: 1,05 netto (Art.-Nr. Z0229P 00 101) RA 2: 1,25 netto (Art.-Nr. Z0229P 00 10P) RA 3: 1,50 netto (Art.-Nr. Z0229P 00 103) für 900 x 600 mm: RA 1: 1,10 netto (Art.-Nr. Z0229P 00 301) RA 2: 1,30 netto (Art.-Nr. Z0229P 00 30P) RA 3: 1,55 netto (Art.-Nr. Z0229P 00 303)											
229-30		Taxi Aufstellung rechts	630 x 420 900 x 600												
229-11		Taxi Aufstellung links	630 x 420 900 x 600	43,00 68,00	57,00 98,00	69,00 123,00	55,00 96,00	73,00 133,00	84,00 158,00	70,00 108,00	73,00 118,00	82,00 137,00	77,00 118,00	83,00 136,00	94,00 162,00
229-21		Taxi Aufstellung links	630 x 420 900 x 600												
229-31		Taxi Aufstellung links	630 x 420 900 x 600												
237		Radweg	Ø 420 Ø 600	28,00 39,00	41,00 58,00	49,00 74,00	40,00 67,00	54,00 94,00	63,00 109,00	56,00 66,00	62,00 71,00	67,00 84,00	53,00 72,00	58,00 81,00	67,00 97,00
238		Reitweg	Ø 420 Ø 600	35,00 49,00	51,00 73,00	61,00 92,00	50,00 84,00	68,00 117,00	79,00 136,00	70,00 82,00	77,00 89,00	84,00 104,00	66,00 90,00	73,00 101,00	84,00 121,00
239		Gehweg	Ø 420 Ø 600												
240		Gemeinsamer Geh- und Radweg	Ø 420 Ø 600	28,00 39,00	41,00 58,00	49,00 74,00	40,00 67,00	54,00 94,00	63,00 109,00	56,00 66,00	62,00 71,00	67,00 84,00	53,00 72,00	58,00 81,00	67,00 97,00
241-30		Getrennter Rad- und Gehweg, Radweg links	Ø 420 Ø 600												
241-31		Getrennter Rad- und Gehweg, Radweg rechts	Ø 420 Ø 600												
242.1		Beginn einer Fußgängerzone	600 x 600 840 x 840	48,00 95,00	69,00 131,00	86,00 165,00	67,00 127,00	93,00 170,00	110,00 205,00	71,00 131,00	78,00 143,00	91,00 171,00	87,00 189,00	97,00 209,00	114,00 254,00

Nr.	Zeichen	Bedeutung	Maße in mm	Flachform 2 mm			Flachform 3 mm			Rundform			Alform		
				Folie RA1	Folie RA2	Folie RA3	Folie RA1	Folie RA2	Folie RA3	Folie RA1	Folie RA2	Folie RA3	Folie RA1	Folie RA2	Folie RA3
242.2		Ende einer Fußgängerzone	600 x 600 840 x 840	48,00 95,00	69,00 131,00	86,00 165,00	67,00 127,00	93,00 170,00	110,00 205,00	71,00 131,00	78,00 143,00	91,00 171,00	87,00 189,00	97,00 209,00	114,00 254,00
242.1-40		Fußgängerzone doppelseitig (Rückseite Z. 242.2)	600 x 600 840 x 840	66,00 128,00	103,00 186,00	137,00 258,00	87,00 163,00	129,00 228,00	164,00 302,00	- -	- -	- -	- -	- -	- -
244.1		Beginn einer Fahrradstraße	600 x 600	48,00	69,00	86,00	67,00	93,00	110,00	71,00	78,00	91,00	87,00	97,00	114,00
244.2		Ende einer Fahrradstraße	600 x 600	48,00	69,00	86,00	67,00	93,00	110,00	71,00	78,00	91,00	87,00	97,00	114,00
244.1-40		Fahrradstraße doppelseitig (Rückseite Z. 244.2)	600 x 600	66,00	103,00	137,00	87,00	129,00	164,00	-	-	-	-	-	-
245		Bussonderfahrstreifen	Ø 420 Ø 600	28,00 39,00	41,00 58,00	49,00 74,00	40,00 67,00	54,00 94,00	63,00 109,00	56,00 66,00	62,00 71,00	67,00 84,00	53,00 72,00	58,00 81,00	67,00 97,00
250		Verbot für Fahrzeuge aller Art	Ø 420 Ø 600 Ø 750												
251		Verbot für Kraftwagen	Ø 420 Ø 600 Ø 750	28,00 39,00 78,00	41,00 58,00 107,00	49,00 74,00 132,00	40,00 67,00 105,00	54,00 94,00 137,00	63,00 109,00 164,00	56,00 66,00 108,00	62,00 71,00 117,00	67,00 84,00 139,00	53,00 72,00 148,00	58,00 81,00 160,00	67,00 97,00 196,00
253		Verbot für Kraftfahrzeuge über 3,5 t	Ø 420 Ø 600 Ø 750												
254		Verbot für Radverkehr	Ø 420 Ø 600	28,00 39,00	41,00 58,00	49,00 74,00	40,00 67,00	54,00 94,00	63,00 109,00	56,00 66,00	62,00 71,00	67,00 84,00	53,00 72,00	58,00 81,00	67,00 97,00
255		Verbot für Krafträder	Ø 420 Ø 600 Ø 750	28,00 39,00 78,00	41,00 58,00 107,00	49,00 74,00 132,00	40,00 67,00 105,00	54,00 94,00 137,00	63,00 109,00 164,00	56,00 66,00 108,00	62,00 71,00 117,00	67,00 84,00 139,00	53,00 72,00 148,00	58,00 81,00 160,00	67,00 97,00 196,00
257-50		Verbot für Mofas	Ø 420 Ø 600												
257-51		Verbot für Reiter	Ø 420 Ø 600												
257-52		Verbot für Gespannfuhrwerke	Ø 420 Ø 600	28,00 39,00	41,00 58,00	49,00 74,00	40,00 67,00	54,00 94,00	63,00 109,00	56,00 66,00	62,00 71,00	67,00 84,00	53,00 72,00	58,00 81,00	67,00 97,00
257-53		Verbot für Viehtrieb	Ø 420 Ø 600												
257-54		Verbot für Kraftomnibusse	Ø 420 Ø 600												

















VERKEHRSZEICHEN

Nr.	Zeichen	Bedeutung	Maße in mm	Flachform 2 mm			Flachform 3 mm			Rundform			Alform			
				Folie RA1	Folie RA2	Folie RA3	Folie RA1	Folie RA2	Folie RA3	Folie RA1	Folie RA2	Folie RA3	Folie RA1	Folie RA2	Folie RA3	
257-55		Verbot für Personenkraftwagen	Ø 420 Ø 600													
257-56		Verbot für Personenkraftwagen mit Anhänger	Ø 420 Ø 600													
257-57		Verbot für Lastkraftwagen mit Anhänger	Ø 420 Ø 600	28,00 39,00	41,00 58,00	49,00 74,00	40,00 67,00	54,00 94,00	63,00 109,00	56,00 66,00	62,00 71,00	67,00 84,00	53,00 72,00	58,00 81,00	67,00 97,00	
257-58		Verbot für Kraftfahrzeuge und Züge, die nicht schneller als 25 km/h fahren können oder dürfen	Ø 420 Ø 600													
259		Verbot für Fußgänger	Ø 420 Ø 600													
260		Verbot für Kraftfahrzeuge	Ø 420 Ø 600 Ø 750	28,00 39,00 78,00	41,00 58,00 107,00	49,00 74,00 132,00	40,00 67,00 105,00	54,00 94,00 137,00	63,00 109,00 164,00	56,00 66,00 108,00	62,00 71,00 117,00	67,00 84,00 139,00	53,00 72,00 148,00	58,00 81,00 160,00	67,00 97,00 196,00	
261		Verbot für kennzeichnungspflichtige Kraftfahrzeuge mit gefährlichen Gütern	Ø 600 Ø 750	39,00 78,00	58,00 107,00	74,00 132,00	67,00 105,00	94,00 137,00	109,00 164,00	66,00 108,00	71,00 117,00	84,00 139,00	72,00 148,00	81,00 160,00	97,00 196,00	
262-..*		Tatsächliche Masse	Ø 420 Ø 600 Ø 750	28,00 39,00 78,00	41,00 58,00 107,00	49,00 74,00 132,00	40,00 67,00 105,00	54,00 94,00 137,00	63,00 109,00 164,00	56,00 66,00 108,00	62,00 71,00 117,00	67,00 84,00 139,00	53,00 72,00 148,00	58,00 81,00 160,00	67,00 97,00 196,00	
* Unternummer steht jeweils für den Zahlenwert: Zum Beispiel: Zeichen 262-5,5 = 5,5 t tatsächliche Masse																
263-..*		Tatsächliche Achslast	Ø 600 Ø 750	39,00 78,00	58,00 107,00	74,00 132,00	67,00 105,00	94,00 137,00	109,00 164,00	66,00 108,00	71,00 117,00	84,00 139,00	72,00 148,00	81,00 160,00	97,00 196,00	
* Unternummer steht jeweils für den Zahlenwert: Zum Beispiel: Zeichen 263-8 = 8 t tatsächliche Achslast																
264-..*		Tatsächliche Breite	Ø 420 Ø 600 Ø 750	28,00 39,00 78,00	41,00 58,00 107,00	49,00 74,00 132,00	40,00 67,00 105,00	54,00 94,00 137,00	63,00 109,00 164,00	56,00 66,00 108,00	62,00 71,00 117,00	67,00 84,00 139,00	53,00 72,00 148,00	58,00 81,00 160,00	67,00 97,00 196,00	
* Unternummer steht jeweils für den Zahlenwert: Zum Beispiel: Zeichen 264-2,5 = 2,5 m tatsächliche Breite																
265-..*		Tatsächliche Höhe	Ø 420 Ø 600 Ø 750	28,00 39,00 78,00	41,00 58,00 107,00	49,00 74,00 132,00	40,00 67,00 105,00	54,00 94,00 137,00	63,00 109,00 164,00	56,00 66,00 108,00	62,00 71,00 117,00	67,00 84,00 139,00	53,00 72,00 148,00	58,00 81,00 160,00	67,00 97,00 196,00	
* Unternummer steht jeweils für den Zahlenwert: Zum Beispiel: Zeichen 265-3,8 = 3,8 m tatsächliche Höhe																
266-..*		Tatsächliche Länge	Ø 600 Ø 750	39,00 78,00	58,00 107,00	74,00 132,00	67,00 105,00	94,00 137,00	109,00 164,00	66,00 108,00	71,00 117,00	84,00 139,00	72,00 148,00	81,00 160,00	97,00 196,00	
* Unternummer steht jeweils für den Zahlenwert: Zum Beispiel: Zeichen 266-10 = 10 m tatsächliche Länge																
267		Verbot der Einfahrt	Ø 420 Ø 600 Ø 750	28,00 39,00 78,00	41,00 58,00 107,00	49,00 74,00 132,00	40,00 67,00 105,00	54,00 94,00 137,00	63,00 109,00 164,00	56,00 66,00 108,00	62,00 71,00 117,00	67,00 84,00 139,00	53,00 72,00 148,00	58,00 81,00 160,00	67,00 97,00 196,00	
268		Schneeketten vorgeschrieben	Ø 600 Ø 750	49,00 97,00	73,00 134,00	92,00 165,00	84,00 131,00	117,00 172,00	136,00 205,00	82,00 135,00	89,00 147,00	104,00 174,00	90,00 185,00	101,00 200,00	121,00 244,00	
269		Verbot für Fahrzeuge mit wassergefährdender Ladung	Ø 600 Ø 750	39,00 78,00	58,00 107,00	74,00 132,00	67,00 105,00	94,00 137,00	109,00 164,00	66,00 108,00	71,00 117,00	84,00 139,00	72,00 148,00	81,00 160,00	97,00 196,00	
270.1		Beginn einer Verkehrsverbotszone zur Verminderung schädlicher Luftverunreinigungen in einer Zone	600 x 600 840 x 840	48,00 95,00	69,00 131,00	86,00 165,00	67,00 127,00	93,00 170,00	110,00 205,00	71,00 131,00	78,00 143,00	91,00 171,00	87,00 189,00	97,00 209,00	114,00 254,00	

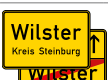
Nr.	Zeichen	Bedeutung	Maße in mm	Flachform 2 mm			Flachform 3 mm			Rundform			Alform		
				Folie RA1	Folie RA2	Folie RA3	Folie RA1	Folie RA2	Folie RA3	Folie RA1	Folie RA2	Folie RA3	Folie RA1	Folie RA2	Folie RA3
270.2		Ende einer Verkehrsverbotszone zur Verminderung schädlicher Luftverunreinigungen in einer Zone	600 x 600 840 x 840	48,00 95,00	69,00 131,00	86,00 165,00	67,00 127,00	93,00 170,00	110,00 205,00	71,00 131,00	78,00 143,00	91,00 171,00	87,00 189,00	97,00 209,00	114,00 254,00
270.1-40		Verkehrsverbotszone zur Verminderung schädlicher Luftverunreinigungen in einer Zone; doppelseitig (Rückseite Z. 270.2)	600 x 600 840 x 840	66,00 128,00	103,00 186,00	137,00 258,00	87,00 163,00	129,00 228,00	164,00 302,00	- -	- -	- -	- -	- -	- -
272		Verbot des Wendens	Ø 600 Ø 750	49,00 97,00	73,00 134,00	92,00 165,00	84,00 131,00	117,00 172,00	136,00 205,00	82,00 135,00	89,00 147,00	104,00 174,00	90,00 185,00	101,00 200,00	121,00 244,00
273-..*		Verbot des Unterschreitens des angegebenen Mindestabstandes	Ø 600 Ø 750	39,00 78,00	58,00 107,00	74,00 132,00	67,00 105,00	94,00 137,00	109,00 164,00	66,00 108,00	71,00 117,00	84,00 139,00	72,00 148,00	81,00 160,00	97,00 196,00
* Unternummer steht jeweils für den Zahlenwert, zum Beispiel: Zeichen 273-30 = 30 m; Zeichen 273-20 = 20 m															
274-..*		Zulässige Höchstgeschwindigkeit	Ø 420 Ø 600 Ø 750	28,00 39,00 78,00	41,00 58,00 107,00	49,00 74,00 132,00	40,00 67,00 105,00	54,00 94,00 137,00	63,00 109,00 164,00	56,00 66,00 108,00	62,00 71,00 117,00	67,00 84,00 139,00	53,00 72,00 148,00	58,00 81,00 160,00	67,00 97,00 196,00
Für 274-5 bis 274-130 gilt: Unternummer steht jeweils für den Zahlenwert: ab 10 in vollen Zehnern.															
274.1		Beginn einer Tempo 30-Zone	600 x 600 840 x 840												
274.1-20		Beginn einer Tempo 20-Zone in verkehrsberuhigten Geschäftsbereichen (einseitig)	600 x 600 840 x 840	48,00 95,00	69,00 131,00	86,00 165,00	67,00 127,00	93,00 170,00	110,00 205,00	71,00 131,00	78,00 143,00	91,00 171,00	87,00 189,00	97,00 209,00	114,00 254,00
274.2		Ende einer Tempo 30-Zone	600 x 600 840 x 840												
274.2-20		Ende einer Tempo 20-Zone in verkehrsberuhigten Geschäftsbereichen (einseitig)	600 x 600 840 x 840												
274.1-40		Beginn einer Tempo 30-Zone doppelseitig (Rückseite Z 274.2)	600 x 600 840 x 840	66,00 128,00	103,00 186,00	137,00 258,00	87,00 163,00	129,00 228,00	164,00 302,00	- -	- -	- -	- -	- -	- -
274.1-41		Beginn einer Tempo 20-Zone in verkehrsberuhigten Geschäftsbereichen doppelseitig (Rückseite Z 274.2-20)	600 x 600 840 x 840												
275-..*		Vorgeschriebene Mindestgeschwindigkeit	Ø 600 Ø 750	49,00 97,00	73,00 134,00	92,00 165,00	84,00 131,00	117,00 172,00	136,00 205,00	82,00 135,00	89,00 147,00	104,00 174,00	90,00 185,00	101,00 200,00	121,00 244,00
* Unternummer steht jeweils für den Zahlenwert. Zum Beispiel: 275-30 = 30 km/h; 275-120 = 120 km/h															
276		Überholverbot für Kraftfahrzeuge aller Art	Ø 600 Ø 750	39,00 78,00	58,00 107,00	74,00 132,00	67,00 105,00	94,00 137,00	109,00 164,00	66,00 108,00	71,00 117,00	84,00 139,00	72,00 148,00	81,00 160,00	97,00 196,00
277		Überholverbot für Kraftfahrzeuge über 3,5 t	Ø 600 Ø 750												
278-..*		Ende der zulässigen Höchstgeschwindigkeit	Ø 420 Ø 600 Ø 750	28,00 39,00 78,00	41,00 58,00 107,00	49,00 74,00 132,00	40,00 67,00 105,00	54,00 94,00 137,00	63,00 109,00 164,00	56,00 66,00 108,00	62,00 71,00 117,00	67,00 84,00 139,00	53,00 72,00 148,00	58,00 81,00 160,00	67,00 97,00 196,00
Für 278-5 bis 278-130 gilt: Unternummer steht jeweils für den Zahlenwert, ab 10 in vollen Zehnern.															
279-..*		Ende der vorgeschriebenen Mindestgeschwindigkeit	Ø 600 Ø 750	49,00 97,00	73,00 134,00	92,00 165,00	84,00 131,00	117,00 172,00	136,00 205,00	82,00 135,00	89,00 147,00	104,00 174,00	90,00 185,00	101,00 200,00	121,00 244,00
* Unternummer steht jeweils für den Zahlenwert. Zum Beispiel: 279-30 = 30 km/h; 279-120 = 120 km/h															

VERKEHRSZEICHEN

Nr.	Zeichen	Bedeutung	Maße in mm	Flachform 2 mm			Flachform 3 mm			Rundform			Alform		
				Folie RA1	Folie RA2	Folie RA3	Folie RA1	Folie RA2	Folie RA3	Folie RA1	Folie RA2	Folie RA3	Folie RA1	Folie RA2	Folie RA3
280		Ende des Überholverbots für Kraftfahrzeuge aller Art	Ø 600 Ø 750												
281		Ende des Überholverbots für Kraftfahrzeuge über 3,5 t	Ø 600 Ø 750	39,00 78,00	58,00 107,00	74,00 132,00	67,00 105,00	94,00 137,00	109,00 164,00	66,00 108,00	71,00 117,00	84,00 139,00	72,00 148,00	81,00 160,00	97,00 196,00
282		Ende sämtlicher streckenbezogener Geschwindigkeitsbeschränkungen und Überholverbote	Ø 600 Ø 750												
283		Absolutes Haltverbot	Ø 420 Ø 600 Ø 750												
283-10		Absolutes Haltverbot Anfang, Aufstellung rechts	Ø 420 Ø 600 Ø 750												
283-11		Absolutes Haltverbot Ende, Aufstellung links	Ø 420 Ø 600 Ø 750												
283-20		Absolutes Haltverbot Ende, Aufstellung rechts	Ø 420 Ø 600 Ø 750												
283-21		Absolutes Haltverbot Anfang, Aufstellung links	Ø 420 Ø 600 Ø 750												
283-30		Absolutes Haltverbot Mitte, Aufstellung rechts	Ø 420 Ø 600 Ø 750	28,00 39,00 78,00	41,00 58,00 107,00	49,00 74,00 132,00	40,00 67,00 105,00	54,00 94,00 137,00	63,00 109,00 164,00	56,00 66,00 108,00	62,00 71,00 117,00	67,00 84,00 139,00	53,00 72,00 148,00	58,00 81,00 160,00	67,00 97,00 196,00
283-31		Absolutes Haltverbot Mitte, Aufstellung links	Ø 420 Ø 600 Ø 750	Gestanzte Folien-Pfeile einzeln für Zeichen 283-10, -20, -30, -11, -21, -31 sowie 286-10, -20, -30, -11, -21, -31: für Ø 420 mm: RA 1: 1,05 netto (Art.-Nr. Z0283P 00 101) RA 2: 1,25 netto (Art.-Nr. Z0283P 00 10P) RA 3: 1,50 netto (Art.-Nr. Z0283P 00 103) für Ø 600 mm: RA 1: 1,10 netto (Art.-Nr. Z0283P 00 301) RA 2: 1,30 netto (Art.-Nr. Z0283P 00 30P) RA 3: 1,55 netto (Art.-Nr. Z0283P 00 303) für Ø 750 mm: RA 1: 1,15 netto (Art.-Nr. Z0283P 00 501) RA 2: 1,35 netto (Art.-Nr. Z0283P 00 50P) RA 3: 1,60 netto (Art.-Nr. Z0283P 00 503)											
286		Eingeschränktes Haltverbot	Ø 420 Ø 600 Ø 750												
286-10		Eingeschränktes Haltverbot Anfang, Aufstellung rechts	Ø 420 Ø 600 Ø 750												
286-11		Eingeschränktes Haltverbot Ende, Aufstellung links	Ø 420 Ø 600 Ø 750												
286-20		Eingeschränktes Haltverbot Ende, Aufstellung rechts	Ø 420 Ø 600 Ø 750												
286-21		Eingeschränktes Haltverbot Anfang, Aufstellung links	Ø 420 Ø 600 Ø 750												
286-30		Eingeschränktes Haltverbot Mitte, Aufstellung rechts	Ø 420 Ø 600 Ø 750												

Nr.	Zeichen	Bedeutung	Maße in mm	Flachform 2 mm			Flachform 3 mm			Rundform			Alform		
				Folie RA1	Folie RA2	Folie RA3	Folie RA1	Folie RA2	Folie RA3	Folie RA1	Folie RA2	Folie RA3	Folie RA1	Folie RA2	Folie RA3
286-31		Eingeschränktes Haltverbot Mitte, Aufstellung links	Ø 420 Ø 600 Ø 750	28,00 39,00 78,00	41,00 58,00 107,00	49,00 74,00 132,00	40,00 67,00 105,00	54,00 94,00 137,00	63,00 109,00 164,00	56,00 66,00 108,00	62,00 71,00 117,00	67,00 84,00 139,00	53,00 72,00 148,00	58,00 81,00 160,00	67,00 97,00 196,00
290.1		Beginn eines eingeschränkten Haltverbots für eine Zone.	600 x 600 840 x 840	48,00 95,00	69,00 131,00	86,00 165,00	67,00 127,00	93,00 170,00	110,00 205,00	71,00 131,00	78,00 143,00	91,00 171,00	87,00 189,00	97,00 209,00	114,00 254,00
290.2		Ende eines eingeschränkten Haltverbots für eine Zone	600 x 600 840 x 840												
290.1-40		Beginn eines eingeschränkten Haltverbots für eine Zone, doppelseitig (Rückseite Z. 290.2)	600 x 600 840 x 840	66,00 128,00	103,00 186,00	137,00 258,00	87,00 163,00	129,00 228,00	164,00 302,00	- -	- -	- -	- -	- -	- -
301		Vorfahrt	SL 630 SL 900	29,00 43,00	39,00 62,00	47,00 78,00	38,00 65,00	51,00 91,00	59,00 105,00	75,00 75,00	77,00 80,00	83,00 93,00	58,00 83,00	63,00 92,00	71,00 108,00
306		Vorfahrtsstraße	420 x 420 600 x 600 840 x 840	31,00 48,00 -	43,00 69,00 -	51,00 86,00 -	40,00 67,00 127,00	53,00 93,00 170,00	61,00 110,00 205,00	56,00 71,00 131,00	61,00 78,00 143,00	66,00 91,00 171,00	60,00 87,00 189,00	65,00 97,00 209,00	73,00 114,00 254,00
307		Ende der Vorfahrtsstraße	420 x 420 600 x 600 840 x 840												
308		Vorrang vor dem Gegenverkehr	420 x 420 600 x 600	31,00 48,00	43,00 69,00	51,00 86,00	40,00 67,00	53,00 93,00	61,00 110,00	56,00 71,00	61,00 78,00	66,00 91,00	60,00 87,00	65,00 97,00	73,00 114,00
310		Ortstafel Vorderseite	600 x 900 840 x 1260	111,00 -	153,00 -	177,00 -	139,00 225,00	188,00 298,00	212,00 345,00	149,00 -	159,00 -	177,00 -	175,00 334,00	193,00 365,00	219,00 426,00
311		Ortstafel Rückseite	600 x 900 840 x 1260												
310-40		Ortstafel doppelseitig (Rückseite Z. 311)	600 x 900 840 x 1260	175,00 -	246,00 -	296,00 -	204,00 304,00	282,00 419,00	332,00 512,00	- -	- -	- -	- -	- -	- -
314		Parken	420 x 420 600 x 600 840 x 840												
314-10		Parken Anfang (Aufstellung rechts) Parken Ende (Aufstellung links)	420 x 420 600 x 600 840 x 840	31,00 48,00 95,00	43,00 69,00 131,00	51,00 86,00 165,00	40,00 67,00 127,00	53,00 93,00 170,00	61,00 110,00 205,00	56,00 71,00 131,00	61,00 78,00 143,00	66,00 91,00 171,00	60,00 87,00 189,00	65,00 97,00 209,00	73,00 114,00 254,00
314-20		Parken Ende (Aufstellung rechts) Parken Anfang (Aufstellung links)	420 x 420 600 x 600 840 x 840												
314-30		Parken Mitte (Aufstellung rechts oder links)	420 x 420 600 x 600 840 x 840												
314-50		Parkhaus, Parkgarage	420 x 420 600 x 600 840 x 840												

















VERKEHRSZEICHEN

Nr.	Zeichen	Bedeutung	Maße in mm	Flachform 2 mm			Flachform 3 mm			Rundform			Alform		
				Folie RA1	Folie RA2	Folie RA3	Folie RA1	Folie RA2	Folie RA3	Folie RA1	Folie RA2	Folie RA3	Folie RA1	Folie RA2	Folie RA3
314.1		Beginn einer Parkraum-bewirtschaftungszone	600 x 600 840 x 840	48,00 95,00	69,00 131,00	86,00 165,00	67,00 127,00	93,00 170,00	110,00 205,00	71,00 131,00	78,00 143,00	91,00 171,00	87,00 189,00	97,00 209,00	114,00 254,00
314.2		Ende einer Parkraum-bewirtschaftungszone	600 x 600 840 x 840												
314.1-40		Beginn einer Parkraum-bewirtschaftungszone doppelseitig (Rückseite Z. 314.2)	600 x 600 840 x 840	66,00 128,00	103,00 186,00	137,00 258,00	87,00 163,00	129,00 228,00	164,00 302,00	- -	- -	- -	- -	- -	- -
315-50		Parken auf Gehwegen halb in Fahrtr. links	630 x 420 900 x 600												
315-51		Parken auf Gehwegen halb in Fahrtr. links Anfang	630 x 420 900 x 600												
315-52		Parken auf Gehwegen halb in Fahrtr. links Ende	630 x 420 900 x 600												
315-53		Parken auf Gehwegen halb in Fahrtr. links Mitte	630 x 420 900 x 600												
315-55		Parken auf Gehwegen halb in Fahrtr. rechts	630 x 420 900 x 600												
315-56		Parken auf Gehwegen halb in Fahrtr. rechts Anfang	630 x 420 900 x 600	43,00 68,00	57,00 98,00	69,00 123,00	55,00 96,00	73,00 133,00	84,00 158,00	70,00 108,00	73,00 118,00	82,00 137,00	77,00 118,00	83,00 136,00	94,00 162,00
315-57		Parken auf Gehwegen halb in Fahrtr. rechts Ende	630 x 420 900 x 600												
315-58		Parken auf Gehwegen halb in Fahrtr. rechts Mitte	630 x 420 900 x 600												
315-60		Parken auf Gehwegen ganz in Fahrtr. links	630 x 420 900 x 600												
315-61		Parken auf Gehwegen ganz in Fahrtr. links Anfang	630 x 420 900 x 600												
315-62		Parken auf Gehwegen ganz in Fahrtr. links Ende	630 x 420 900 x 600												
315-63		Parken auf Gehwegen ganz in Fahrtr. links Mitte	630 x 420 900 x 600												
315-65		Parken auf Gehwegen ganz in Fahrtr. rechts	630 x 420 900 x 600												

















Nr.	Zeichen	Bedeutung	Maße in mm	Flachform 2 mm			Flachform 3 mm			Rundform			Alform		
				Folie RA1	Folie RA2	Folie RA3	Folie RA1	Folie RA2	Folie RA3	Folie RA1	Folie RA2	Folie RA3	Folie RA1	Folie RA2	Folie RA3
315-66		Parken auf Gehwegen ganz in Fahrtr. rechts Anfang	630 x 420 900 x 600												
315-67		Parken auf Gehwegen ganz in Fahrtr. rechts Ende	630 x 420 900 x 600												
315-68		Parken auf Gehwegen ganz in Fahrtr. rechts Mitte	630 x 420 900 x 600												
315-70		Parken auf Gehwegen halb quer zur Fahrtr. links	630 x 420 900 x 600												
315-71		Parken auf Gehwegen halb quer zur Fahrtr. links Anfang	630 x 420 900 x 600												
315-72		Parken auf Gehwegen halb quer zur Fahrtr. links Ende	630 x 420 900 x 600												
315-73		Parken auf Gehwegen halb quer zur Fahrtr. links Mitte	630 x 420 900 x 600												
315-75		Parken auf Gehwegen halb quer zur Fahrtr. rechts	630 x 420 900 x 600												
315-76		Parken auf Gehwegen halb quer zur Fahrtr. rechts Anfang	630 x 420 900 x 600	43,00 68,00	57,00 98,00	69,00 123,00	55,00 96,00	73,00 133,00	84,00 158,00	70,00 108,00	73,00 118,00	82,00 137,00	77,00 118,00	83,00 136,00	94,00 162,00
315-77		Parken auf Gehwegen halb quer zur Fahrtr. rechts Ende	630 x 420 900 x 600												
315-78		Parken auf Gehwegen halb quer zur Fahrtr. rechts Mitte	630 x 420 900 x 600												
315-80		Parken auf Gehwegen ganz quer zur Fahrtr. links	630 x 420 900 x 600												
315-81		Parken auf Gehwegen ganz quer zur Fahrtr. links Anfang	630 x 420 900 x 600												
315-82		Parken auf Gehwegen ganz quer zur Fahrtr. links Ende	630 x 420 900 x 600												
315-83		Parken auf Gehwegen ganz quer zur Fahrtr. links Mitte	630 x 420 900 x 600												
315-85		Parken auf Gehwegen ganz quer zur Fahrtr. rechts	630 x 420 900 x 600												















VERKEHRSZEICHEN

Nr.	Zeichen	Bedeutung	Maße in mm	Flachform 2 mm			Flachform 3 mm			Rundform			Alform		
				Folie RA1	Folie RA2	Folie RA3	Folie RA1	Folie RA2	Folie RA3	Folie RA1	Folie RA2	Folie RA3	Folie RA1	Folie RA2	Folie RA3
315-86		Parken auf Gehwegen ganz quer zur Fahrtr. rechts Anfang	630 x 420 900 x 600												
315-87		Parken auf Gehwegen ganz quer zur Fahrtr. rechts Ende	630 x 420 900 x 600	43,00 68,00	57,00 98,00	69,00 123,00	55,00 96,00	73,00 133,00	84,00 158,00	70,00 108,00	73,00 118,00	82,00 137,00	77,00 118,00	83,00 136,00	94,00 162,00
315-88		Parken auf Gehwegen ganz quer zur Fahrtr. rechts Mitte	630 x 420 900 x 600												
316		Parken und Reisen	420 x 420 600 x 600	39,00 59,00	53,00 86,00	63,00 107,00	50,00 83,00	67,00 117,00	76,00 138,00	70,00 89,00	76,00 98,00	82,00 114,00	75,00 109,00	81,00 121,00	92,00 143,00
316-50		Parken und Mitfahren	420 x 420 600 x 600												
317		Wandererparkplatz	630 x 420 900 x 600	43,00 68,00	57,00 98,00	69,00 123,00	55,00 96,00	73,00 133,00	84,00 158,00	70,00 108,00	73,00 118,00	82,00 137,00	77,00 118,00	83,00 136,00	94,00 162,00
325.1		Beginn eines verkehrsberuhigten Bereichs	420 x 630 600 x 900	43,00 68,00	57,00 98,00	69,00 123,00	55,00 96,00	73,00 133,00	84,00 158,00	70,00 108,00	73,00 118,00	82,00 137,00	77,00 118,00	83,00 136,00	94,00 162,00
325.2		Ende eines verkehrsberuhigten Bereichs	420 x 630 600 x 900												
325.1-40		Verkehrsberuhigter Bereich doppelseitig (Rückseite Z. 325.2)	420 x 630 600 x 900	57,00 89,00	80,00 137,00	103,00 187,00	71,00 118,00	97,00 174,00	119,00 224,00	- -	- -	- -	- -	- -	- -
327		Tunnel	600 x 600 840 x 840	59,00 119,00	86,00 164,00	107,00 206,00	83,00 159,00	117,00 213,00	138,00 256,00	89,00 164,00	98,00 178,00	114,00 213,00	109,00 237,00	121,00 261,00	143,00 317,00
327-50		Tunnel, mit Längenangabe in m	900 x 600 1260 x 840	85,00 -	123,00 -	154,00 -	120,00 226,00	167,00 305,00	197,00 363,00	135,00 -	147,00 -	171,00 -	147,00 328,00	170,00 367,00	202,00 444,00
327-51		Tunnel, mit Längenangabe in km	900 x 600 1260 x 840												
328		Nothalte- und Pannenbucht	600 x 600 840 x 840	59,00 119,00	86,00 164,00	107,00 206,00	83,00 159,00	117,00 213,00	138,00 256,00	89,00 164,00	98,00 178,00	114,00 213,00	109,00 237,00	121,00 261,00	143,00 317,00
330.1		Autobahn	600 x 600 840 x 840	48,00 95,00	69,00 131,00	86,00 165,00	67,00 127,00	93,00 170,00	110,00 205,00	71,00 131,00	78,00 143,00	91,00 171,00	87,00 189,00	97,00 209,00	114,00 254,00
330.2		Ende der Autobahn	600 x 600 840 x 840												
331.1		Kraftfahrstraße	600 x 600 840 x 840	59,00 119,00	86,00 164,00	107,00 206,00	83,00 159,00	117,00 213,00	138,00 256,00	89,00 164,00	98,00 178,00	114,00 213,00	109,00 237,00	121,00 261,00	143,00 317,00













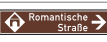

Nr.	Zeichen	Bedeutung	Maße in mm	Flachform 2 mm			Flachform 3 mm			Rundform			Alform			
				Folie RA1	Folie RA2	Folie RA3	Folie RA1	Folie RA2	Folie RA3	Folie RA1	Folie RA2	Folie RA3	Folie RA1	Folie RA2	Folie RA3	
331.2		Ende der Kraftfahrstraße	600 x 600 840 x 840	59,00 119,00	86,00 164,00	107,00 206,00	83,00 159,00	117,00 213,00	138,00 256,00	89,00 164,00	98,00 178,00	114,00 213,00	109,00 237,00	121,00 261,00	143,00 317,00	
332		Ausfahrttafel auf der Autobahn	Ausführung nach RWBA	Siehe Preisliste „Vor- und Tabellenwegweiser“ (Katalog Seite 73)												
332.1		Ausfahrttafel auf anderen Straßen außerhalb der Autobahn	Ausführung nach RWB													
332.1-20		Ausfahrttafel auf anderen Straßen außerhalb der Autobahn in weiß, mit Zielen nach Zeichen 432	Ausführung nach RWB													
333		Ausfahrt von der Autobahn	950 x 3450	-	-	-	-	-	-	-	-	-	-	1.635,00	1.815,00	1.996,00
333.1		Ausfahrt von anderen Straßen außerhalb der Autobahn	500 x 2000	213,00	302,00	344,00	248,00	344,00	386,00	-	-	-	508,00	563,00	618,00	
333.1-20		Ausfahrt von anderen Straßen außerhalb der Autobahn in weiß (in Verbindung mit Z.332.1-20)	500 x 2000	-	-	-	-	-	-	-	-	-	-	-	-	
350-10		Fußgängerüberweg, Aufstellung rechts	750 x 750	76,00	104,00	131,00	102,00	135,00	163,00	105,00	116,00	135,00	156,00	171,00	207,00	
350-20		Fußgängerüberweg, Aufstellung links	750 x 750	-	-	-	-	-	-	-	-	-	-	-	-	
350-40		Fußgängerüberweg, doppelseitig (-10/-20)	750 x 750	102,00	151,00	206,00	130,00	185,00	241,00	-	-	-	-	-	-	
354		Wasserschutzgebiet	630 x 420 900 x 600 1260 x 840	43,00 68,00 -	57,00 98,00 -	69,00 123,00 -	55,00 96,00 181,00	73,00 133,00 244,00	84,00 158,00 291,00	70,00 108,00 -	73,00 118,00 -	82,00 137,00 -	77,00 118,00 263,00	83,00 136,00 294,00	94,00 162,00 355,00	
356		Verkehrshelfer	630 x 420 900 x 600	43,00 68,00	57,00 98,00	69,00 123,00	55,00 96,00	73,00 133,00	84,00 158,00	70,00 108,00	73,00 118,00	82,00 137,00	77,00 118,00	83,00 136,00	94,00 162,00	
357		Sackgasse	420 x 420 600 x 600	31,00 48,00	43,00 69,00	51,00 86,00	40,00 67,00	53,00 93,00	61,00 110,00	56,00 71,00	61,00 78,00	66,00 91,00	60,00 87,00	65,00 97,00	73,00 114,00	
357-50		Für Radverkehr und Fußgänger durchlässige Sackgasse	630 x 420 900 x 600	-	-	-	-	-	-	-	-	-	-	-	-	
357-51		Für Fußgänger durchlässige Sackgasse	630 x 420 900 x 600	43,00 68,00	57,00 98,00	69,00 123,00	55,00 96,00	73,00 133,00	84,00 158,00	70,00 108,00	73,00 118,00	82,00 137,00	77,00 118,00	83,00 136,00	94,00 162,00	
357-52		Für Radverkehr durchlässige Sackgasse	630 x 420 900 x 600	-	-	-	-	-	-	-	-	-	-	-	-	

VERKEHRSZEICHEN

Nr.	Zeichen	Bedeutung	Maße in mm	Flachform 2 mm			Flachform 3 mm			Rundform			Alform			
				Folie RA1	Folie RA2	Folie RA3	Folie RA1	Folie RA2	Folie RA3	Folie RA1	Folie RA2	Folie RA3	Folie RA1	Folie RA2	Folie RA3	
358		Erste Hilfe	600 x 600 840 x 840													
363		Polizei	600 x 600 840 x 840													
365-50		Fernsprecher	600 x 600 840 x 840													
365-51		Notrufsäule	600 x 600 840 x 840													
365-52		Tankstelle	600 x 600 840 x 840													
365-53		Tankstelle mit Autogas	600 x 600 840 x 840													
365-54		Tankstelle mit Erdgas	600 x 600 840 x 840													
365-55		Autobahnhotel	600 x 600 840 x 840	59,00 119,00	86,00 164,00	107,00 206,00	83,00 159,00	117,00 213,00	138,00 256,00	89,00 164,00	98,00 178,00	114,00 213,00	109,00 237,00	121,00 261,00	143,00 317,00	
365-56		Autobahngasthaus	600 x 600 840 x 840													
365-57		Autobahnkiosk	600 x 600 840 x 840													
365-58		Toilette	600 x 600 840 x 840													
365-59		Autobahnkapelle	600 x 600 840 x 840													
365-60		Zelt- und Wohnwagenplatz	600 x 600 840 x 840													
365-61		Informationsstelle	600 x 600 840 x 840													
365-62		Pannenhilfe	600 x 600 840 x 840													
365-63		Fußgänger- unterführung	600 x 600 840 x 840													

Nr.	Zeichen	Bedeutung	Maße in mm	Flachform 2 mm			Flachform 3 mm			Rundform			Alform			
				Folie RA1	Folie RA2	Folie RA3	Folie RA1	Folie RA2	Folie RA3	Folie RA1	Folie RA2	Folie RA3	Folie RA1	Folie RA2	Folie RA3	
365-64		Fußgänger- überführung	600 x 600 840 x 840													
365-65		Ladestation für Elektrofahrzeuge	600 x 600 840 x 840													
365-66		Wasserstofftank- stelle	600 x 600 840 x 840	59,00 119,00	86,00 164,00	107,00 206,00	83,00 159,00	117,00 213,00	138,00 256,00	89,00 164,00	98,00 178,00	114,00 213,00	109,00 237,00	121,00 261,00	143,00 317,00	
365-67		Wohnmobilplatz	600 x 600 840 x 840													
365-68		Wohnmobil- und Wohnwagenplatz	600 x 600 840 x 840													
385		Ortshinweistafel	350 x 1050	67,00	91,00	110,00	89,00	117,00	136,00	112,00	118,00	133,00	158,00	169,00	195,00	
386.1		Touristischer Hinweis	Ausführung nach RtB	Preise auf Anfrage												
386.1-10		Touristischer Hinweis als Wegweiser, linksweisend	Ausführung nach RtB													
386.1-20		Touristischer Hinweis als Wegweiser, rechtsweisend	Ausführung nach RtB													
386.1-30		Touristischer Hinweis als Wegweiser und Vorwegweiser geradeaus	Ausführung nach RtB													
386.1-11		Touristischer Hinweis als Vorwegweiser, linksweisend	Ausführung nach RtB													
386.1-21		Touristischer Hinweis als Vorwegweiser, rechtsweisend	Ausführung nach RtB													
386.1-12		Touristischer Hinweis als Pfeilwegweiser, linksweisend	Ausführung nach RtB													
386.1-22		Touristischer Hinweis als Pfeilwegweiser, rechtsweisend	Ausführung nach RtB													
386.1-40		Touristischer Hinweis als Pfeilwegweiser, doppelseitig	Ausführung nach RtB													

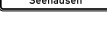

VERKEHRSZEICHEN

Nr.	Zeichen	Bedeutung	Maße in mm	Flachform 2 mm			Flachform 3 mm			Rundform			Alform		
				Folie RA1	Folie RA2	Folie RA3	Folie RA1	Folie RA2	Folie RA3	Folie RA1	Folie RA2	Folie RA3	Folie RA1	Folie RA2	Folie RA3
386.1-50		Touristischer Hinweis mit Bezugsziel Variante „in ...“	Ausführung nach RtB	Preise auf Anfrage											
386.1-51		Touristischer Hinweis mit Bezugsziel Variante „via ...“	Ausführung nach RtB												
386.1-52		Touristischer Hinweis mit Bezugsziel Variante „Richtung ...“	Ausführung nach RtB												
386.1-53		Touristischer Hinweis Fluss oder Kanal	600 x 900	85,00	123,00	154,00	120,00	167,00	197,00	135,00	147,00	171,00	147,00	170,00	202,00
386.2		Touristische Route	Ausführung nach RtB	Preise auf Anfrage											
386.2-10		Touristische Route, Wegweiser linksweisend	Ausführung nach RtB												
386.2-20		Touristische Route, Wegweiser rechtsweisend	Ausführung nach RtB												
386.2-11		Touristische Route, Vorwegweiser linksweisend	Ausführung nach RtB												
386.2-21		Touristische Route, Vorwegweiser rechtsweisend	Ausführung nach RtB												
386.2-12		Touristische Route, Pfeilwegweiser linksweisend	Ausführung nach RtB												
386.2-22		Touristische Route, Pfeilwegweiser rechtsweisend	Ausführung nach RtB												
386.2-40		Touristische Route, Pfeilwegweiser doppelseitig	Ausführung nach RtB												
386.2-30		Touristische Route, Vor-/Wegweiser geradeaus	Ausführung nach RtB												
386.2-51		Touristische Route mit Bezugsziel, Variante „via“	Ausführung nach RtB												
386.2-52		Touristische Route mit Bezugsziel, Variante „Richtung“	Ausführung nach RtB												
386.2-53		Touristische Route als Hinweisschild	Ausführung nach RtB												

Nr.	Zeichen	Bedeutung	Maße in mm	Flachform 2 mm			Flachform 3 mm			Rundform			Alform		
				Folie RA1	Folie RA2	Folie RA3	Folie RA1	Folie RA2	Folie RA3	Folie RA1	Folie RA2	Folie RA3	Folie RA1	Folie RA2	Folie RA3
386.3		Touristische Unter- richtungstafel auf Autobahnen mit mehr als 2 Fahrspuren	2400 x 3600 2800 x 4200	-	-	-	-	-	-	-	-	-	2610,00	2990,00	3500,00
				-	-	-	-	-	-	-	-	-	3552,00	4069,00	4763,00
386.3-50		Erinnerungstafel gemäß „Brocken-Erklärung“	1400 x 2100 1600 x 2400 2000 x 3000	-	-	-	-	-	-	-	-	-	868,00	924,00	1085,00
				-	-	-	-	-	-	-	-	-	1133,00	1206,00	1417,00
				-	-	-	-	-	-	-	-	-	1812,00	2076,00	2430,00
390		Mautpflicht nach dem Bundesfernstraßen- mautgesetz	Ø 600 Ø 750												
390.2		Ende der Maut- pflicht nach dem Bundesfernstraßen- mautgesetz	Ø 600 Ø 750	49,00 97,00	73,00 134,00	92,00 165,00	84,00 131,00	117,00 172,00	136,00 205,00	82,00 135,00	89,00 147,00	104,00 174,00	90,00 185,00	101,00 200,00	121,00 244,00
391		Mautpflichtige Strecke	Ø 600 Ø 750												
392		Zollstelle	Ø 600 Ø 750												
393		Informationstafel an Grenzübergangs- stellen	2400 x 1650 3600 x 2500	-	-	-	-	-	-	-	-	-	1169,00	1244,00	1462,00
				-	-	-	-	-	-	-	-	-	2718,00	3114,00	3645,00
394		Laternenring (selbstklebende Folie)	70 x 1000	15,00	-	-	-	-	-	-	-	-	-	-	-
394-50		Schild für Laternen	70 x 150	14,00	-	-	-	-	-	-	-	-	-	-	-
401		Bundesstraßen	250 x 420	28,00	37,00	43,00	35,00	45,00	50,00	54,00	56,00	60,00	58,00	61,00	67,00
405		Autobahnen	Ausführung nach RWBA	Preise auf Anfrage											
406-50		Knotenpunkte der Autobahnen, ein- oder zweistellige Nummer	650 x 650	70,00	102,00	125,00	93,00	131,00	154,00	-	-	-	124,00	138,00	162,00
406-51		Knotenpunkte der Autobahnen, drei- oder mehrstelli- ge Nummer	580 x 930	90,00	125,00	154,00	121,00	162,00	191,00	-	-	-	202,00	226,00	264,00
410		Europastraßen	250 x 420	28,00	37,00	43,00	35,00	45,00	50,00	54,00	56,00	60,00	58,00	61,00	67,00





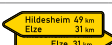











VERKEHRSSZEICHEN

Nr.	Zeichen	Bedeutung	Maße in mm	Flachform 2 mm			Flachform 3 mm			Rundform			Alform		
				Folie RA1	Folie RA2	Folie RA3	Folie RA1	Folie RA2	Folie RA3	Folie RA1	Folie RA2	Folie RA3	Folie RA1	Folie RA2	Folie RA3
415-10		Pfeilwegweiser auf Bundesstraßen, linksweisend	Ausführung nach RWB	Nach RWB 2000 gilt für Pfeilwegweiser folgendes: Geschwindigkeit v ≤ 40 km/h Schriftgröße h = 105 mm Geschwindigkeit v = 50 km/h Schriftgröße h = 126 mm Geschwindigkeit v = 60-70 km/h Schriftgröße h = 140 mm Geschwindigkeit v = 80-100 km/h Schriftgröße h = 175 mm											
415-20		Pfeilwegweiser auf Bundesstraßen, rechtsweisend	Ausführung nach RWB												
		Schriftgröße 105 mm (einzeilig)	350 x 1250 350 x 1400 350 x 1500 350 x 1750 350 x 2000	104,00 109,00 116,00 134,00 152,00	145,00 153,00 163,00 189,00 215,00	164,00 174,00 185,00 215,00 244,00	119,00 125,00 134,00 155,00 176,00	164,00 174,00 185,00 215,00 244,00	182,00 194,00 207,00 240,00 273,00	- - - - -	- - - - -	176,00 - - - -	239,00 255,00 273,00 316,00 359,00	263,00 282,00 302,00 350,00 398,00	287,00 309,00 330,00 383,00 436,00
		Schriftgröße 126 mm (einzeilig)	400 x 1500 400 x 1750 400 x 2000 400 x 2250	131,00 152,00 172,00 193,00	185,00 215,00 244,00 273,00	210,00 244,00 277,00 311,00	152,00 176,00 200,00 224,00	152,00 244,00 277,00 311,00	236,00 273,00 311,00 348,00	- - - -	- - - -	- - - -	310,00 359,00 409,00 458,00	343,00 398,00 453,00 508,00	376,00 436,00 497,00 557,00
		SH 140 mm (einzeilig) SH 105 mm (zweizeilig)	450 x 1500 450 x 1750 450 x 2000 450 x 2250	147,00 170,00 193,00 216,00	207,00 240,00 273,00 306,00	236,00 273,00 311,00 348,00	170,00 197,00 224,00 251,00	236,00 273,00 311,00 348,00	264,00 306,00 348,00 391,00	- - - -	- - - -	- - - -	347,00 403,00 458,00 514,00	384,00 446,00 508,00 570,00	421,00 489,00 557,00 625,00
		Schriftgröße 126 mm (zweizeilig)	500 x 1750 500 x 2000 500 x 2250 500 x 2500	188,00 213,00 - -	266,00 302,00 - -	302,00 344,00 - -	218,00 248,00 278,00 307,00	302,00 344,00 386,00 428,00	339,00 386,00 433,00 480,00	- - - -	- - - -	- - - -	446,00 508,00 570,00 632,00	494,00 563,00 632,00 700,00	542,00 618,00 693,00 769,00
		Schriftgröße 175 mm (einzeilig)	550 x 1750 550 x 2000 550 x 2250 550 x 2500	- - - -	- - - -	- - - -	239,00 272,00 304,00 337,00	332,00 378,00 424,00 470,00	372,00 424,00 475,00 527,00	- - - -	- - - -	- - - -	489,00 557,00 625,00 693,00	542,00 618,00 693,00 769,00	595,00 678,00 761,00 845,00
		Schriftgröße 140 mm (zweizeilig)	600 x 2000 600 x 2250 600 x 2500 600 x 2750	- - - -	- - - -	- - - -	296,00 331,00 367,00 403,00	411,00 461,00 511,00 562,00	461,00 518,00 574,00 631,00	- - - -	- - - -	- - - -	607,00 681,00 755,00 830,00	673,00 755,00 838,00 920,00	739,00 830,00 920,00 1.011,00
		Schriftgröße 175 mm (zweizeilig)	700 x 2250 700 x 2500 700 x 2750 700 x 2800 700 x 3000	- - - - -	- - - - -	- - - - -	385,00 427,00 469,00 478,00 511,00	537,00 595,00 654,00 665,00 712,00	602,00 668,00 734,00 747,00 800,00	- - - - -	- - - - -	- - - - -	792,00 879,00 966,00 983,00 1.052,00	879,00 975,00 1.072,00 1.091,00 1.168,00	966,00 1.072,00 1.177,00 1.199,00 1.283,00
415-40		Pfeilwegweiser auf Bundesstraßen, doppelseitig	Ausführung nach RWB	Nach RWB 2000 gilt für Pfeilwegweiser folgendes: Geschwindigkeit v ≤ 40 km/h Schriftgröße h = 105 mm Geschwindigkeit v = 50 km/h Schriftgröße h = 126 mm Geschwindigkeit v = 60-70 km/h Schriftgröße h = 140 mm Geschwindigkeit v = 80-100 km/h Schriftgröße h = 175 mm											
		Schriftgröße 105 mm (einzeilig)	350 x 1250 350 x 1400 350 x 1500 350 x 1750 350 x 2000	140,00 149,00 159,00 184,00 209,00	197,00 211,00 225,00 261,00 297,00	222,00 239,00 256,00 297,00 338,00	161,00 172,00 184,00 213,00 243,00	222,00 239,00 256,00 297,00 338,00	248,00 268,00 286,00 332,00 379,00	- - - - -	- - - - -	- - - - -	- - - - -	- - - - -	- - - - -
		Schriftgröße 126 mm (einzeilig)	400 x 1500 400 x 1750 400 x 2000 400 x 2250	181,00 209,00 238,00 267,00	256,00 297,00 338,00 379,00	291,00 338,00 384,00 431,00	209,00 243,00 276,00 310,00	291,00 338,00 384,00 431,00	326,00 379,00 431,00 484,00	- - - -	- - - -	- - - -	- - - -	- - - -	- - - -
		SH 140 mm (einzeilig) SH 105 mm (zweizeilig)	450 x 1500 450 x 1750 450 x 2000 450 x 2250	202,00 234,00 267,00 299,00	286,00 332,00 379,00 425,00	326,00 379,00 431,00 484,00	234,00 272,00 310,00 348,00	326,00 379,00 431,00 484,00	365,00 425,00 484,00 543,00	- - - -	- - - -	- - - -	- - - -	- - - -	- - - -
		Schriftgröße 126 mm (zweizeilig)	500 x 1750 500 x 2000 500 x 2250 500 x 2500	260,00 296,00 - -	368,00 419,00 - -	419,00 478,00 - -	301,00 343,00 385,00 427,00	419,00 478,00 537,00 595,00	471,00 537,00 602,00 668,00	- - - -	- - - -	- - - -	- - - -	- - - -	- - - -
		Schriftgröße 175 mm (einzeilig)	550 x 1750 550 x 2000 550 x 2250 550 x 2500	- - - -	- - - -	- - - -	331,00 377,00 423,00 469,00	460,00 525,00 589,00 654,00	517,00 589,00 662,00 734,00	- - - -	- - - -	- - - -	- - - -	- - - -	- - - -
		Schriftgröße 140 mm (zweizeilig)	600 x 2000 600 x 2250 600 x 2500 600 x 2750	- - - -	- - - -	- - - -	410,00 461,00 511,00 561,00	572,00 642,00 712,00 782,00	642,00 721,00 800,00 879,00	- - - -	- - - -	- - - -	- - - -	- - - -	- - - -
		Schriftgröße 175 mm (zweizeilig)	700 x 2250 700 x 2500 700 x 2750 700 x 2800 700 x 3000	- - - - -	- - - - -	- - - - -	536,00 595,00 654,00 665,00 712,00	747,00 829,00 911,00 927,00 993,00	839,00 932,00 1.024,00 1.042,00 1.116,00	- - - - -	- - - - -	- - - - -	- - - - -	- - - - -	- - - - -

Nr.	Zeichen	Bedeutung	Maße in mm	Flachform 2 mm			Flachform 3 mm			Rundform			Alform		
				Folie RA1	Folie RA2	Folie RA3	Folie RA1	Folie RA2	Folie RA3	Folie RA1	Folie RA2	Folie RA3	Folie RA1	Folie RA2	Folie RA3
418-10		Pfeilwegweiser auf sonstigen Straßen, linksweisend	Ausführung nach RWB	Nach RWB 2000 gilt für Pfeilwegweiser folgendes: Geschwindigkeit v ≤ 40 km/h Schrifthöhe h = 105 mm Geschwindigkeit v = 50 km/h Schrifthöhe h = 126 mm Geschwindigkeit v = 60-70 km/h Schrifthöhe h = 140 mm Geschwindigkeit v = 80-100 km/h Schrifthöhe h = 175 mm											
418-20		Pfeilwegweiser auf sonstigen Straßen, rechtsweisend	Ausführung nach RWB												
		Schrifthöhe 105 mm (einzeilig)	350 x 1250 350 x 1400 350 x 1500 350 x 1750 350 x 2000	104,00 109,00 116,00 134,00 152,00	145,00 153,00 163,00 189,00 215,00	164,00 174,00 185,00 215,00 244,00	119,00 125,00 134,00 155,00 176,00	164,00 174,00 185,00 215,00 244,00	182,00 194,00 207,00 240,00 273,00	- - - - -	- - - - -	- - - - -	239,00 255,00 273,00 316,00 359,00	263,00 282,00 302,00 350,00 398,00	287,00 309,00 330,00 383,00 436,00
		Schrifthöhe 126 mm (einzeilig)	400 x 1500 400 x 1750 400 x 2000 400 x 2250	131,00 152,00 172,00 193,00	185,00 215,00 244,00 273,00	210,00 244,00 277,00 311,00	152,00 176,00 200,00 224,00	210,00 244,00 277,00 311,00	236,00 273,00 311,00 348,00	- - - -	- - - -	- - - -	310,00 359,00 409,00 458,00	343,00 398,00 453,00 508,00	376,00 436,00 497,00 557,00
		SH 140 mm (einzeilig) SH 105 mm (zweizeilig)	450 x 1500 450 x 1750 450 x 2000 450 x 2250	147,00 170,00 193,00 216,00	207,00 240,00 273,00 306,00	236,00 273,00 311,00 348,00	170,00 197,00 224,00 251,00	236,00 273,00 311,00 348,00	264,00 306,00 348,00 391,00	- - - -	- - - -	- - - -	347,00 403,00 458,00 514,00	384,00 446,00 508,00 570,00	421,00 489,00 557,00 625,00
		Schrifthöhe 126 mm (zweizeilig)	500 x 1750 500 x 2000 500 x 2250 500 x 2500	188,00 213,00 - -	266,00 302,00 - -	302,00 344,00 - -	218,00 248,00 278,00 307,00	302,00 344,00 386,00 428,00	339,00 386,00 433,00 480,00	- - - -	- - - -	- - - -	446,00 508,00 570,00 632,00	494,00 563,00 632,00 700,00	542,00 618,00 693,00 769,00
		Schrifthöhe 175 mm (einzeilig)	550 x 1750 550 x 2000 550 x 2250 550 x 2500	- - - -	- - - -	- - - -	239,00 272,00 304,00 337,00	322,00 378,00 424,00 470,00	372,00 424,00 475,00 527,00	- - - -	- - - -	- - - -	489,00 557,00 625,00 693,00	542,00 618,00 693,00 769,00	595,00 678,00 761,00 845,00
		Schrifthöhe 140 mm (zweizeilig)	600 x 2000 600 x 2250 600 x 2500 600 x 2750	- - - -	- - - -	- - - -	296,00 331,00 367,00 403,00	411,00 461,00 511,00 562,00	461,00 518,00 574,00 631,00	- - - -	- - - -	- - - -	607,00 681,00 755,00 830,00	673,00 755,00 838,00 920,00	739,00 830,00 920,00 1.011,00
		Schrifthöhe 175 mm (zweizeilig)	700 x 2250 700 x 2500 700 x 2750 700 x 2800 700 x 3000	- - - - -	- - - - -	- - - - -	385,00 427,00 469,00 478,00 511,00	537,00 595,00 654,00 665,00 712,00	602,00 668,00 734,00 747,00 800,00	- - - - -	- - - - -	- - - - -	792,00 879,00 966,00 983,00 1.052,00	879,00 975,00 1.072,00 1.091,00 1.168,00	966,00 1.072,00 1.177,00 1.199,00 1.283,00
418-40		Pfeilwegweiser auf sonstigen Straßen, doppelseitig	Ausführung nach RWB	Nach RWB 2000 gilt für Pfeilwegweiser folgendes: Geschwindigkeit v ≤ 40 km/h Schrifthöhe h = 105 mm Geschwindigkeit v = 50 km/h Schrifthöhe h = 126 mm Geschwindigkeit v = 60-70 km/h Schrifthöhe h = 140 mm Geschwindigkeit v = 80-100 km/h Schrifthöhe h = 175 mm											
		Schrifthöhe 105 mm (einzeilig)	350 x 1250 350 x 1400 350 x 1500 350 x 1750 350 x 2000	140,00 149,00 159,00 184,00 209,00	197,00 211,00 225,00 261,00 297,00	222,00 239,00 256,00 297,00 338,00	161,00 172,00 184,00 213,00 243,00	222,00 239,00 256,00 297,00 338,00	248,00 268,00 286,00 332,00 379,00	- - - - -	- - - - -	- - - - -	- - - - -	- - - - -	- - - - -
		Schrifthöhe 126 mm (einzeilig)	400 x 1500 400 x 1750 400 x 2000 400 x 2250	181,00 209,00 238,00 267,00	256,00 297,00 338,00 379,00	291,00 338,00 384,00 431,00	209,00 243,00 276,00 310,00	291,00 338,00 384,00 431,00	326,00 379,00 431,00 484,00	- - - -	- - - -	- - - -	- - - -	- - - -	- - - -
		SH 140 mm (einzeilig) SH 105 mm (zweizeilig)	450 x 1500 450 x 1750 450 x 2000 450 x 2250	202,00 234,00 267,00 299,00	286,00 332,00 379,00 425,00	326,00 379,00 431,00 484,00	234,00 272,00 310,00 348,00	326,00 379,00 431,00 484,00	365,00 425,00 484,00 543,00	- - - -	- - - -	- - - -	- - - -	- - - -	- - - -
		Schrifthöhe 126 mm (zweizeilig)	500 x 1750 500 x 2000 500 x 2250 500 x 2500	260,00 296,00 - -	368,00 419,00 - -	419,00 478,00 - -	301,00 343,00 385,00 427,00	419,00 478,00 537,00 595,00	471,00 537,00 602,00 668,00	- - - -	- - - -	- - - -	- - - -	- - - -	- - - -
		Schrifthöhe 175 mm (einzeilig)	550 x 1750 550 x 2000 550 x 2250 550 x 2500	- - - -	- - - -	- - - -	331,00 377,00 423,00 469,00	460,00 525,00 589,00 654,00	517,00 589,00 662,00 734,00	- - - -	- - - -	- - - -	- - - -	- - - -	- - - -
		Schrifthöhe 140 mm (zweizeilig)	600 x 2000 600 x 2250 600 x 2500 600 x 2750	- - - -	- - - -	- - - -	410,00 461,00 511,00 561,00	572,00 642,00 712,00 782,00	642,00 721,00 800,00 879,00	- - - -	- - - -	- - - -	- - - -	- - - -	- - - -
		Schrifthöhe 175 mm (zweizeilig)	700 x 2250 700 x 2500 700 x 2750 700 x 2800 700 x 3000	- - - - -	- - - - -	- - - - -	536,00 595,00 654,00 665,00 712,00	747,00 829,00 911,00 927,00 993,00	839,00 932,00 1.024,00 1.042,00 1.116,00	- - - - -	- - - - -	- - - - -	- - - - -	- - - - -	- - - - -



VERKEHRSZEICHEN

Nr.	Zeichen	Bedeutung	Maße in mm	Flachform 2 mm			Flachform 3 mm			Rundform			Alform		
				Folie RA1	Folie RA2	Folie RA3	Folie RA1	Folie RA2	Folie RA3	Folie RA1	Folie RA2	Folie RA3	Folie RA1	Folie RA2	Folie RA3
419-10		Pfeilwegweiser auf sonstigen Straßen mit geringerer Verkehrsbedeutung linksweisend	250 x 1000	84,00	113,00	124,00	93,00	124,00	134,00	98,00	106,00	114,00	177,00	190,00	204,00
419-20		Pfeilwegweiser auf sonstigen Straßen mit geringerer Verkehrsbedeutung rechtsweisend	250 x 1000												
419-40		Pfeilwegweiser auf sonstigen Straßen mit geringerer Verkehrsbedeutung doppelseitig	250 x 1000	105,00	143,00	157,00	117,00	157,00	172,00	-	-	-	-	-	-
421-10		Pfeilwegweiser für KFZ m. einer zul. Gesamtmasse über 3,5 t, linksweisend	350 x 1250	104,00	145,00	164,00	119,00	164,00	182,00	-	-	-	239,00	263,00	287,00
421-20		Pfeilwegweiser für KFZ m. einer zul. Gesamtmasse über 3,5 t, rechtsweisend	350 x 1250												
421-40		Pfeilwegweiser für KFZ m. einer zul. Gesamtmasse über 3,5 t, doppelseitig	350 x 1250	140,00	197,00	222,00	161,00	222,00	248,00	-	-	-	-	-	-
421-11		Pfeilwegweiser für kennzeichnungspflichtige Fahrzeuge mit gefährlichen Gütern, linksweisend	350 x 1250	104,00	145,00	164,00	119,00	164,00	182,00	-	-	-	239,00	263,00	287,00
421-21		Pfeilwegweiser für kennzeichnungspflichtige Fahrzeuge mit gefährlichen Gütern, rechtsweisend	350 x 1250												
421-41		Pfeilwegweiser für kennzeichnungspflichtige Fahrzeuge mit gefährlichen Gütern, doppelseitig	350 x 1250	140,00	197,00	222,00	161,00	222,00	248,00	-	-	-	-	-	-
421-12		Pfeilwegweiser für Fahrzeuge mit wassergefährdender Ladung, linksweisend	350 x 1250	104,00	145,00	164,00	119,00	164,00	182,00	-	-	-	239,00	263,00	287,00
421-22		Pfeilwegweiser für Fahrzeuge mit wassergefährdender Ladung, rechtsweisend	350 x 1250												
421-42		Pfeilwegweiser für Fahrzeuge mit wassergefährdender Ladung, doppelseitig	350 x 1250	140,00	197,00	222,00	161,00	222,00	248,00	-	-	-	-	-	-
422-10		Wegweiser für KFZ m. einer zul. Gesamtmasse über 3,5 t, hier links	630 x 420 900 x 600 1260 x 840												
422-20		Wegweiser für KFZ m. einer zul. Gesamtmasse über 3,5 t, hier rechts	630 x 420 900 x 600 1260 x 840	53,00 85,00	72,00 123,00	86,00 154,00	69,00 120,00 226,00	91,00 167,00 305,00	105,00 197,00 363,00	87,00 135,00	91,00 147,00	102,00 171,00	96,00 147,00 328,00	103,00 170,00 367,00	118,00 202,00 444,00
422-30		Wegweiser für KFZ m. einer zul. Gesamtmasse über 3,5 t, geradeaus	630 x 420 900 x 600 1260 x 840												
422-11		Wegweiser für KFZ m. einer zul. Gesamtmasse über 3,5 t, links einordnen	630 x 420 900 x 600 1260 x 840												

Nr.	Zeichen	Bedeutung	Maße in mm	Flachform 2 mm			Flachform 3 mm			Rundform			Alform		
				Folie RA1	Folie RA2	Folie RA3	Folie RA1	Folie RA2	Folie RA3	Folie RA1	Folie RA2	Folie RA3	Folie RA1	Folie RA2	Folie RA3
422-21		Wegweiser für KFZ m. einer zul. Gesamtmasse über 3,5 t, rechts einordnen	630 x 420 900 x 600 1260 x 840												
422-12		Wegweiser für kennzeichnungspflichtige Fahrzeuge mit gefährlichen Gütern, hier links	630 x 420 900 x 600 1260 x 840												
422-22		Wegweiser für kennzeichnungspflichtige Fahrzeuge mit gefährlichen Gütern, hier rechts	630 x 420 900 x 600 1260 x 840												
422-32		Wegweiser für kennzeichnungspflichtige Fahrzeuge mit gefährlichen Gütern, geradeaus	630 x 420 900 x 600 1260 x 840												
422-13		Wegweiser für kennzeichnungspflichtige Fahrzeuge mit gefährlichen Gütern, links einordnen	630 x 420 900 x 600 1260 x 840												
422-23		Wegweiser für kennzeichnungspflichtige Fahrzeuge mit gefährlichen Gütern, rechts einordnen	630 x 420 900 x 600 1260 x 840	53,00 85,00 -	72,00 123,00 -	86,00 154,00 -	69,00 120,00 226,00	91,00 167,00 305,00	105,00 197,00 363,00	87,00 135,00 -	91,00 147,00 -	102,00 171,00 -	96,00 147,00 328,00	103,00 170,00 367,00	118,00 202,00 444,00
422-14		Wegweiser für Fahrzeuge mit wassergefährdender Ladung, hier links	630 x 420 900 x 600 1260 x 840												
422-24		Wegweiser für Fahrzeuge mit wassergefährdender Ladung, hier rechts	630 x 420 900 x 600 1260 x 840												
422-34		Wegweiser für Fahrzeuge mit wassergefährdender Ladung, geradeaus	630 x 420 900 x 600 1260 x 840												
422-15		Wegweiser für Fahrzeuge mit wassergefährdender Ladung, links einordnen	630 x 420 900 x 600 1260 x 840												
422-25		Wegweiser für Fahrzeuge mit wassergefährdender Ladung, rechts einordnen	630 x 420 900 x 600 1260 x 840												
422-16		Wegweiser für Radverkehr hier links	630 x 420 900 x 600												
422-26		Wegweiser für Radverkehr hier rechts	630 x 420 900 x 600												
422-36		Wegweiser für Radverkehr geradeaus	630 x 420 900 x 600	53,00 85,00	72,00 123,00	86,00 154,00	69,00 120,00	91,00 167,00	105,00 197,00	87,00 135,00	91,00 147,00	102,00 171,00	96,00 147,00	103,00 170,00	118,00 202,00
422-17		Wegweiser für Radverkehr links einordnen	630 x 420 900 x 600												
422-27		Wegweiser für Radverkehr rechts einordnen	630 x 420 900 x 600												



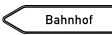
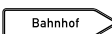













VERKEHRSZEICHEN

Nr.	Zeichen	Bedeutung	Maße in mm	Flachform 2 mm			Flachform 3 mm			Rundform			Alform		
				Folie RA1	Folie RA2	Folie RA3	Folie RA1	Folie RA2	Folie RA3	Folie RA1	Folie RA2	Folie RA3	Folie RA1	Folie RA2	Folie RA3
430-10		Pfeilwegweiser zur Autobahn, linksweisend	Ausführung nach RWB	Nach RWB 2000 gilt für Pfeilwegweiser folgendes: Geschwindigkeit v ≤ 40 km/h Schriftgröße h = 105 mm Geschwindigkeit v = 50 km/h Schriftgröße h = 126 mm Geschwindigkeit v = 60-70 km/h Schriftgröße h = 140 mm Geschwindigkeit v = 80-100 km/h Schriftgröße h = 175 mm											
430-20		Pfeilwegweiser zur Autobahn, rechtsweisend	Ausführung nach RWB												
		Schriftgröße 105 mm (einzeilig)	350 x 1250 350 x 1400 350 x 1500 350 x 1750 350 x 2000	104,00 109,00 116,00 134,00 152,00	145,00 153,00 163,00 189,00 215,00	164,00 174,00 185,00 215,00 244,00	119,00 125,00 134,00 155,00 176,00	164,00 174,00 185,00 215,00 244,00	182,00 194,00 207,00 240,00 273,00	- - - - -	- - - - -	176,00	239,00 255,00 273,00 316,00 359,00	263,00 282,00 302,00 350,00 398,00	287,00 309,00 330,00 383,00 436,00
		Schriftgröße 126 mm (einzeilig)	400 x 1500 400 x 1750 400 x 2000 400 x 2250	131,00 152,00 172,00 193,00	185,00 215,00 244,00 273,00	210,00 244,00 277,00 311,00	152,00 176,00 200,00 224,00	152,00 244,00 277,00 311,00	236,00 273,00 311,00 348,00	- - - -	- - - -	-	310,00 359,00 409,00 458,00	343,00 398,00 453,00 508,00	376,00 436,00 497,00 557,00
		SH 140 mm (einzeilig) SH 105 mm (zweizeilig)	450 x 1500 450 x 1750 450 x 2000 450 x 2250	147,00 170,00 193,00 216,00	207,00 240,00 273,00 306,00	236,00 273,00 311,00 348,00	170,00 197,00 224,00 251,00	236,00 273,00 311,00 348,00	264,00 306,00 348,00 391,00	- - - -	- - - -	-	347,00 403,00 458,00 514,00	384,00 446,00 508,00 570,00	421,00 489,00 557,00 625,00
		Schriftgröße 126 mm (zweizeilig)	500 x 1750 500 x 2000 500 x 2250 500 x 2500	188,00 213,00 - -	266,00 302,00 - -	302,00 344,00 - -	218,00 248,00 278,00 307,00	302,00 344,00 386,00 428,00	339,00 386,00 433,00 480,00	- - - -	- - - -	-	446,00 508,00 570,00 632,00	494,00 563,00 632,00 700,00	542,00 618,00 693,00 769,00
		Schriftgröße 175 mm (einzeilig)	550 x 1750 550 x 2000 550 x 2250 550 x 2500	- - - -	- - - -	- - - -	239,00 272,00 304,00 337,00	332,00 378,00 424,00 470,00	372,00 424,00 475,00 527,00	- - - -	- - - -	-	489,00 557,00 625,00 693,00	542,00 618,00 693,00 769,00	595,00 678,00 761,00 845,00
		Schriftgröße 140 mm (zweizeilig)	600 x 2000 600 x 2250 600 x 2500 600 x 2750	- - - -	- - - -	- - - -	296,00 331,00 367,00 403,00	411,00 461,00 511,00 562,00	461,00 518,00 574,00 631,00	- - - -	- - - -	-	607,00 681,00 755,00 830,00	673,00 755,00 838,00 920,00	739,00 830,00 920,00 1.011,00
		Schriftgröße 175 mm (zweizeilig)	700 x 2250 700 x 2500 700 x 2750 700 x 2800 700 x 3000	- - - - -	- - - - -	- - - - -	385,00 427,00 469,00 478,00 511,00	537,00 595,00 654,00 665,00 712,00	602,00 668,00 734,00 747,00 800,00	- - - - -	- - - - -	-	792,00 879,00 966,00 983,00 1.052,00	879,00 975,00 1.072,00 1.091,00 1.168,00	966,00 1.072,00 1.177,00 1.199,00 1.283,00
430-40		Pfeilwegweiser zur Autobahn, doppel-seitig	Ausführung nach RWB	Nach RWB 2000 gilt für Pfeilwegweiser folgendes: Geschwindigkeit v ≤ 40 km/h Schriftgröße h = 105 mm Geschwindigkeit v = 50 km/h Schriftgröße h = 126 mm Geschwindigkeit v = 60-70 km/h Schriftgröße h = 140 mm Geschwindigkeit v = 80-100 km/h Schriftgröße h = 175 mm											
		Schriftgröße 105 mm (einzeilig)	350 x 1250 350 x 1400 350 x 1500 350 x 1750 350 x 2000	140,00 149,00 159,00 184,00 209,00	197,00 211,00 225,00 261,00 297,00	222,00 239,00 256,00 297,00 338,00	161,00 172,00 184,00 213,00 243,00	222,00 239,00 256,00 297,00 338,00	248,00 268,00 286,00 332,00 379,00	- - - - -	- - - - -	-	- - - - -	- - - - -	- - - - -
		Schriftgröße 126 mm (einzeilig)	400 x 1500 400 x 1750 400 x 2000 400 x 2250	181,00 209,00 238,00 267,00	256,00 297,00 338,00 379,00	291,00 338,00 384,00 431,00	209,00 243,00 276,00 310,00	291,00 338,00 384,00 431,00	326,00 379,00 431,00 484,00	- - - -	- - - -	-	- - - -	- - - -	- - - -
		SH 140 mm (einzeilig) SH 105 mm (zweizeilig)	450 x 1500 450 x 1750 450 x 2000 450 x 2250	202,00 234,00 267,00 299,00	286,00 332,00 379,00 425,00	326,00 379,00 431,00 484,00	234,00 272,00 310,00 348,00	326,00 379,00 431,00 484,00	365,00 425,00 484,00 543,00	- - - -	- - - -	-	- - - -	- - - -	- - - -
		Schriftgröße 126 mm (zweizeilig)	500 x 1750 500 x 2000 500 x 2250 500 x 2500	260,00 296,00 - -	368,00 419,00 - -	419,00 478,00 - -	301,00 343,00 385,00 427,00	419,00 478,00 537,00 595,00	471,00 537,00 602,00 668,00	- - - -	- - - -	-	- - - -	- - - -	- - - -
		Schriftgröße 175 mm (einzeilig)	550 x 1750 550 x 2000 550 x 2250 550 x 2500	- - - -	- - - -	- - - -	331,00 377,00 423,00 469,00	460,00 525,00 589,00 654,00	517,00 589,00 662,00 734,00	- - - -	- - - -	-	- - - -	- - - -	- - - -
		Schriftgröße 140 mm (zweizeilig)	600 x 2000 600 x 2250 600 x 2500 600 x 2750	- - - -	- - - -	- - - -	410,00 461,00 511,00 561,00	572,00 642,00 712,00 782,00	642,00 721,00 800,00 879,00	- - - -	- - - -	-	- - - -	- - - -	- - - -
		Schriftgröße 175 mm (zweizeilig)	700 x 2250 700 x 2500 700 x 2750 700 x 2800 700 x 3000	- - - - -	- - - - -	- - - - -	536,00 595,00 654,00 665,00 712,00	747,00 829,00 911,00 927,00 993,00	839,00 932,00 1.024,00 1.042,00 1.116,00	- - - - -	- - - - -	-	- - - - -	- - - - -	- - - - -

Nr.	Zeichen	Bedeutung	Maße in mm	Flachform 2 mm			Flachform 3 mm			Rundform			Alform														
				Folie RA1	Folie RA2	Folie RA3	Folie RA1	Folie RA2	Folie RA3	Folie RA1	Folie RA2	Folie RA3	Folie RA1	Folie RA2	Folie RA3												
432-10		Pfeilwegweiser zu Zielen mit erheblicher Verkehrsbedeutung, linksweisend	Ausführung nach RWB	Nach RWB 2000 gilt für Pfeilwegweiser folgendes: Geschwindigkeit v ≤ 40 km/h Schriftgröße h = 105 mm Geschwindigkeit v = 50 km/h Schriftgröße h = 126 mm Geschwindigkeit v = 60-70 km/h Schriftgröße h = 140 mm Geschwindigkeit v = 80-100 km/h Schriftgröße h = 175 mm																							
432-20		Pfeilwegweiser zu Zielen mit erheblicher Verkehrsbedeutung, rechtsweisend	Ausführung nach RWB																								
		Schriftgröße 105 mm (einzeilig)	350 x 1250 350 x 1400 350 x 1500 350 x 1750 350 x 2000													104,00 109,00 116,00 134,00 152,00	145,00 153,00 163,00 189,00 215,00	164,00 174,00 185,00 215,00 244,00	119,00 125,00 134,00 155,00 176,00	164,00 174,00 185,00 215,00 244,00	182,00 194,00 207,00 240,00 273,00	- - - - -	- 159,00 - - -	- - - - -	239,00 255,00 273,00 316,00 359,00	263,00 282,00 302,00 350,00 398,00	287,00 309,00 330,00 383,00 436,00
		Schriftgröße 126 mm (einzeilig)	400 x 1500 400 x 1750 400 x 2000 400 x 2250													131,00 152,00 172,00 193,00	185,00 215,00 244,00 273,00	210,00 244,00 277,00 311,00	152,00 176,00 200,00 224,00	210,00 244,00 277,00 311,00	236,00 273,00 311,00 348,00	- - - -	- - - -	- - - -	310,00 359,00 409,00 458,00	343,00 398,00 453,00 508,00	376,00 436,00 497,00 557,00
		SH 140 mm (einzeilig) SH 105 mm (zweizeilig)	450 x 1500 450 x 1750 450 x 2000 450 x 2250	147,00 170,00 193,00 216,00	207,00 240,00 273,00 306,00	236,00 273,00 311,00 348,00	170,00 197,00 224,00 251,00	236,00 273,00 311,00 348,00	264,00 306,00 348,00 391,00	- - - -	- - - -	- - - -	347,00 403,00 458,00 514,00	384,00 446,00 508,00 570,00	421,00 489,00 557,00 625,00												
		Schriftgröße 126 mm (zweizeilig)	500 x 1750 500 x 2000 500 x 2250 500 x 2500	188,00 213,00 - -	266,00 302,00 - -	302,00 344,00 - -	218,00 248,00 278,00 307,00	302,00 344,00 386,00 428,00	339,00 386,00 433,00 480,00	- - - -	- - - -	- - - -	446,00 508,00 570,00 632,00	494,00 563,00 632,00 700,00	542,00 618,00 693,00 769,00												
		Schriftgröße 175 mm (einzeilig)	550 x 1750 550 x 2000 550 x 2250 550 x 2500	- - - -	- - - -	- - - -	239,00 272,00 304,00 337,00	332,00 378,00 424,00 470,00	372,00 424,00 475,00 527,00	- - - -	- - - -	- - - -	489,00 557,00 625,00 693,00	542,00 618,00 693,00 769,00	595,00 678,00 761,00 845,00												
		Schriftgröße 140 mm (zweizeilig)	600 x 2000 600 x 2250 600 x 2500 600 x 2750	- - - -	- - - -	- - - -	296,00 331,00 367,00 403,00	411,00 461,00 511,00 562,00	461,00 518,00 574,00 631,00	- - - -	- - - -	- - - -	607,00 681,00 755,00 830,00	673,00 755,00 838,00 920,00	739,00 830,00 920,00 1.011,00												
		Schriftgröße 175 mm (zweizeilig)	700 x 2250 700 x 2500 700 x 2750 700 x 2800 700 x 3000	- - - - -	- - - - -	- - - - -	385,00 427,00 469,00 478,00 511,00	537,00 595,00 654,00 665,00 712,00	602,00 668,00 734,00 747,00 800,00	- - - - -	- - - - -	- - - - -	792,00 879,00 966,00 983,00 1.052,00	879,00 975,00 1.072,00 1.091,00 1.168,00	966,00 1.072,00 1.177,00 1.199,00 1.283,00												
432-40		Pfeilwegweiser zu Zielen mit erheblicher Verkehrsbedeutung, doppelseitig	Ausführung nach RWB	Nach RWB 2000 gilt für Pfeilwegweiser folgendes: Geschwindigkeit v ≤ 40 km/h Schriftgröße h = 105 mm Geschwindigkeit v = 50 km/h Schriftgröße h = 126 mm Geschwindigkeit v = 60-70 km/h Schriftgröße h = 140 mm Geschwindigkeit v = 80-100 km/h Schriftgröße h = 175 mm																							
		Schriftgröße 105 mm (einzeilig)	350 x 1250 350 x 1400 350 x 1500 350 x 1750 350 x 2000	140,00 149,00 159,00 184,00 209,00	197,00 211,00 225,00 261,00 297,00	222,00 239,00 256,00 297,00 338,00	161,00 172,00 184,00 213,00 243,00	222,00 239,00 256,00 297,00 338,00	248,00 268,00 286,00 332,00 379,00	- - - - -	- - - - -	- - - - -	- - - - -	- - - - -	- - - - -												
		Schriftgröße 126 mm (einzeilig)	400 x 1500 400 x 1750 400 x 2000 400 x 2250	181,00 209,00 238,00 267,00	256,00 297,00 338,00 379,00	291,00 338,00 384,00 431,00	209,00 243,00 276,00 310,00	291,00 338,00 384,00 431,00	326,00 379,00 431,00 484,00	- - - -	- - - -	- - - -	- - - -	- - - -	- - - -												
		SH 140 mm (einzeilig) SH 105 mm (zweizeilig)	450 x 1500 450 x 1750 450 x 2000 450 x 2250	202,00 234,00 267,00 299,00	286,00 332,00 379,00 425,00	326,00 379,00 431,00 484,00	234,00 272,00 310,00 348,00	326,00 379,00 431,00 484,00	365,00 425,00 484,00 543,00	- - - -	- - - -	- - - -	- - - -	- - - -	- - - -												
		Schriftgröße 126 mm (zweizeilig)	500 x 1750 500 x 2000 500 x 2250 500 x 2500	260,00 296,00 - -	368,00 419,00 - -	419,00 478,00 - -	301,00 343,00 385,00 427,00	419,00 478,00 537,00 595,00	471,00 537,00 602,00 668,00	- - - -	- - - -	- - - -	- - - -	- - - -	- - - -												
		Schriftgröße 175 mm (einzeilig)	550 x 1750 550 x 2000 550 x 2250 550 x 2500	- - - -	- - - -	- - - -	331,00 377,00 423,00 469,00	460,00 525,00 589,00 654,00	517,00 589,00 662,00 734,00	- - - -	- - - -	- - - -	- - - -	- - - -	- - - -												
		Schriftgröße 140 mm (zweizeilig)	600 x 2000 600 x 2250 600 x 2500 600 x 2750	- - - -	- - - -	- - - -	410,00 461,00 511,00 561,00	572,00 642,00 712,00 782,00	642,00 721,00 800,00 879,00	- - - -	- - - -	- - - -	- - - -	- - - -	- - - -												
		Schriftgröße 175 mm (zweizeilig)	700 x 2250 700 x 2500 700 x 2750 700 x 2800 700 x 3000	- - - - -	- - - - -	- - - - -	536,00 595,00 654,00 665,00 712,00	747,00 829,00 911,00 927,00 993,00	839,00 932,00 1.024,00 1.042,00 1.116,00	- - - - -	- - - - -	- - - - -	- - - - -	- - - - -	- - - - -												

VERKEHRSZEICHEN













Nr.	Zeichen	Bedeutung	Maße in mm	Flachform 2 mm			Flachform 3 mm			Rundform			Alform																																						
				Folie RA1	Folie RA2	Folie RA3	Folie RA1	Folie RA2	Folie RA3	Folie RA1	Folie RA2	Folie RA3	Folie RA1	Folie RA2	Folie RA3																																				
434-50		Tabellenwegweiser kompakte Form	Ausführung nach RWB	Siehe Preisliste „Vor- und Tabellenwegweiser“ (Katalog Seite 73)																																															
434-51		Tabellenwegweiser teilaufgelöste Form	Ausführung nach RWB																																																
434-52		Tabellenwegweiser aufgelöste Form (nur innerorts) mit Bundesstraßennummer	Ausführung nach RWB																																																
434-53		Tabellenwegweiser aufgelöste Form (nur innerorts) ohne Bundesstraßennummer	Ausführung nach RWB																																																
437		Straßennamensschild		Siehe Preisliste „Straßennamenschilder“ (Katalog Seite 106)																																															
438		Vorwegweiser außerhalb von Autobahnen	Ausführung nach RWB	Siehe Preisliste „Vor- und Tabellenwegweiser“ (Katalog Seite 73)																																															
439		Gegliedertes Vorwegweiser außerhalb von Autobahnen	Ausführung nach RWB																																																
440		Vorwegweiser zur Autobahn	Ausführung nach RWBA																																																
441		Gegliedertes Vorwegweiser zur Autobahn	Ausführung nach RWBA																																																
442-10		Vorwegweiser für KFZ m. einer zul. Gesamtmasse über 3,5 t, linksweisend *	630 x 420 900 x 600 1260 x 840	<table border="1"> <tr> <td>53,00</td> <td>72,00</td> <td>86,00</td> <td>69,00</td> <td>91,00</td> <td>105,00</td> <td>87,00</td> <td>91,00</td> <td>102,00</td> <td>96,00</td> <td>103,00</td> <td>118,00</td> </tr> <tr> <td>85,00</td> <td>123,00</td> <td>154,00</td> <td>120,00</td> <td>167,00</td> <td>197,00</td> <td>135,00</td> <td>147,00</td> <td>171,00</td> <td>147,00</td> <td>170,00</td> <td>202,00</td> </tr> <tr> <td>-</td> <td>-</td> <td>-</td> <td>226,00</td> <td>305,00</td> <td>363,00</td> <td>-</td> <td>-</td> <td>-</td> <td>328,00</td> <td>367,00</td> <td>444,00</td> </tr> </table>												53,00	72,00	86,00	69,00	91,00	105,00	87,00	91,00	102,00	96,00	103,00	118,00	85,00	123,00	154,00	120,00	167,00	197,00	135,00	147,00	171,00	147,00	170,00	202,00	-	-	-	226,00	305,00	363,00	-	-	-	328,00	367,00	444,00
53,00	72,00	86,00	69,00													91,00	105,00	87,00	91,00	102,00	96,00	103,00	118,00																												
85,00	123,00	154,00	120,00													167,00	197,00	135,00	147,00	171,00	147,00	170,00	202,00																												
-	-	-	226,00													305,00	363,00	-	-	-	328,00	367,00	444,00																												
442-20		Vorwegweiser für KFZ m. einer zul. Gesamtmasse über 3,5 t, rechtsweisend *	630 x 420 900 x 600 1260 x 840																																																
442-11		Vorwegweiser für kennzeichnungspflichtige Fahrzeuge mit gefährlichen Gütern, linksweisend *	630 x 420 900 x 600 1260 x 840																																																
442-21		Vorwegweiser für kennzeichnungspflichtige Fahrzeuge mit gefährlichen Gütern, rechtsweisend *	630 x 420 900 x 600 1260 x 840																																																
442-12		Vorwegweiser für Fahrzeuge mit wassergefährdender Ladung, linksweisend *	630 x 420 900 x 600 1260 x 840																																																
442-22		Vorwegweiser für Fahrzeuge mit wassergefährdender Ladung, rechtsweisend *	630 x 420 900 x 600 1260 x 840																																																
442-13		Vorwegweiser für Radverkehr linksweisend *	630 x 420 900 x 600																																																
				* Vorwegweiser geradeaus gemäß Z. 422																																															

Nr.	Zeichen	Bedeutung	Maße in mm	Flachform 2 mm			Flachform 3 mm			Rundform			Alform			
				Folie RA1	Folie RA2	Folie RA3	Folie RA1	Folie RA2	Folie RA3	Folie RA1	Folie RA2	Folie RA3	Folie RA1	Folie RA2	Folie RA3	
442-23		Vorwegweiser für Radverkehr rechtsweisend *	630 x 420 900 x 600													
442-50		Vorwegweiser für KFZ mit einer zulässigen Gesamtmasse über 3,5 t, ohne Pfeilsymbol	630 x 420 900 x 600													
442-51		Vorwegweiser für kennzeichnungspflichtige Fahrzeuge mit gefährlichen Gütern, ohne Pfeilsymbol	630 x 420 900 x 600	53,00 85,00	72,00 123,00	86,00 154,00	69,00 120,00	91,00 167,00	105,00 197,00	87,00 135,00	91,00 147,00	102,00 171,00	96,00 147,00	103,00 170,00	118,00 202,00	
442-52		Vorwegweiser für Fahrzeuge mit wassergefährdender Ladung, ohne Pfeilsymbol	630 x 420 900 x 600													
442-53		Vorwegweiser für Radverkehr, ohne Pfeilsymbol	630 x 420 900 x 600													
448		Ankündigungstafel	Ausführung nach RWBA	Siehe Preisliste „Vor- und Tabellenwegweiser“ (Katalog Seite 73)												
448-50		Ankündigungstafel auf anderen Straßen außerhalb von Autobahnen	Ausführung nach RWB													
448.1		Autohof	2000 x 2800	-	-	-	-	-	-	-	-	-	-	1652,00	1759,00	2067,00
449		Vorwegweiser auf Autobahnen	Ausführung nach RWBA	Siehe Preisliste „Vor- und Tabellenwegweiser“ (Katalog Seite 73)												
449-50		Vorwegweiser auf anderen Straßen außerhalb von Autobahnen	Ausführung nach RWB													
450-50		Ankündigungsbake einstreifig	1500 x 650													
450-51		Ankündigungsbake zweistreifig	1500 x 650													
450-52		Ankündigungsbake dreistreifig	1500 x 650	-	-	-	208,00	286,00	338,00	-	-	-	308,00	351,00	419,00	
450-53		Ankündigungsbake gelb, einstreifig	1500 x 650													
450-54		Ankündigungsbake gelb, zweistreifig	1500 x 650													
450-55		Ankündigungsbake gelb, dreistreifig	1500 x 650													

VERKEHRSZEICHEN

Nr.	Zeichen	Bedeutung	Maße in mm	Flachform 2 mm			Flachform 3 mm			Rundform			Alform		
				Folie RA1	Folie RA2	Folie RA3	Folie RA1	Folie RA2	Folie RA3	Folie RA1	Folie RA2	Folie RA3	Folie RA1	Folie RA2	Folie RA3
453		Entfernungstafel	Ausführung nach RWBA	Siehe Preisliste „Vor- und Tabellenwegweiser“ (Katalog Seite 73)											
453-50		Entfernungstafel auf autobahnähnlich ausgebauten, zweibahnigen Straßen	Ausführung nach RWB												
454-10		Umleitungswegweiser, linksweisend	350 x 1250	104,00	145,00	164,00	119,00	164,00	182,00	-	-	-	239,00	263,00	287,00
454-20		Umleitungswegweiser, rechtsweisend	350 x 1250												
454-40		Umleitungswegweiser, doppelseitig	350 x 1250	140,00	197,00	222,00	161,00	222,00	248,00	-	-	-	-	-	-
455.1-10		Ankündigung oder Fortsetzung der Umleitung, Vorankündigung links	630 x 420 900 x 600 1260 x 840												
455.1-20		Ankündigung oder Fortsetzung der Umleitung, Vorankündigung rechts	630 x 420 900 x 600 1260 x 840												
455.1-30		Ankündigung oder Fortsetzung der Umleitung, Vorankündigung geradeaus	630 x 420 900 x 600 1260 x 840												
455.1-11		Ankündigung oder Fortsetzung der Umleitung, hier links	630 x 420 900 x 600 1260 x 840	43,00 68,00	57,00 98,00	69,00 123,00	55,00 96,00 181,00	73,00 133,00 244,00	84,00 158,00 291,00	70,00 108,00	73,00 118,00	82,00 137,00	77,00 118,00 263,00	83,00 136,00 294,00	94,00 162,00 355,00
455.1-21		Ankündigung oder Fortsetzung der Umleitung, hier rechts	630 x 420 900 x 600 1260 x 840												
455.1-12		Ankündigung oder Fortsetzung der Umleitung, links einordnen	630 x 420 900 x 600 1260 x 840												
455.1-22		Ankündigung oder Fortsetzung der Umleitung, rechts einordnen	630 x 420 900 x 600 1260 x 840												
455.1-50		Ankündigung oder Fortsetzung der Umleitung, ohne Pfeilsymbol	630 x 420 900 x 600	43,00 68,00	57,00 98,00	69,00 123,00	55,00 96,00	73,00 133,00	84,00 158,00	70,00 108,00	73,00 118,00	82,00 137,00	77,00 118,00	83,00 136,00	94,00 162,00
455.2		Ende der Umleitung	630 x 420 900 x 600 1260 x 840	43,00 68,00	57,00 98,00	69,00 123,00	55,00 96,00 181,00	73,00 133,00 244,00	84,00 158,00 291,00	70,00 108,00	73,00 118,00	82,00 137,00	77,00 118,00 263,00	83,00 136,00 294,00	94,00 162,00 355,00
457.1		Umleitungsankündigung	350 x 1050	54,00	73,00	88,00	71,00	93,00	109,00	90,00	94,00	107,00	126,00	135,00	156,00
457.2		Ende der Umleitung	350 x 1050												

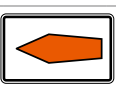
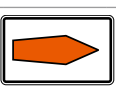
* Variante mit außermittig angeordnetem „U“ und Nummerierung. Bitte bei Bestellung angeben, welche Ausrichtung das „U“ haben soll.

Nr.	Zeichen	Bedeutung	Maße in mm	Flachform 2 mm			Flachform 3 mm			Rundform			Alform		
				Folie RA1	Folie RA2	Folie RA3	Folie RA1	Folie RA2	Folie RA3	Folie RA1	Folie RA2	Folie RA3	Folie RA1	Folie RA2	Folie RA3
458		Planskizze (Art.-Nr.: Z0458 00 95..) mit Text (Art.-Nr.: Z0458 01 95..) ohne Text	1600 x 1250 o. Ausf. nach RUB	Schilder der Ausführung „2mm“ entsprechen nicht der RAL-Gütezeichenvorschrift.											
				320,00	380,00	476,00	400,00	466,00	564,00	-	-	-	590,00	628,00	738,00
				272,00	323,00	405,00	340,00	397,00	480,00	-	-	-	502,00	534,00	628,00
460-10		Bedarfsumleitung, Vorankündigung links	630 x 420 900 x 600 1260 x 840												
460-20		Bedarfsumleitung, Vorankündigung rechts	630 x 420 900 x 600 1260 x 840												
460-30		Bedarfsumleitung, Vorankündigung geradeaus	630 x 420 900 x 600 1260 x 840												
460-11		Bedarfsumleitung, hier links	630 x 420 900 x 600 1260 x 840	53,00 85,00 -	72,00 123,00 -	86,00 154,00 -	69,00 120,00 226,00	91,00 167,00 305,00	105,00 197,00 363,00	87,00 135,00 -	91,00 147,00 -	102,00 171,00 -	96,00 147,00 328,00	103,00 170,00 367,00	118,00 202,00 444,00
460-21		Bedarfsumleitung, hier rechts	630 x 420 900 x 600 1260 x 840												
460-12		Bedarfsumleitung, links einordnen	630 x 420 900 x 600 1260 x 840												
460-22		Bedarfsumleitung, rechts einordnen	630 x 420 900 x 600 1260 x 840												
460-50		Bedarfsumleitung, ohne Pfeilsymbol	630 x 420 900 x 600	53,00 85,00	72,00 123,00	86,00 154,00	69,00 120,00	91,00 167,00	105,00 197,00	87,00 135,00	91,00 147,00	102,00 171,00	96,00 147,00	103,00 170,00	118,00 202,00
466		Weiterführende Bedarfsumleitung	1600 x 1250	320,00	380,00	476,00	400,00	466,00	564,00	-	-	-	590,00	628,00	738,00
				Schilder der Ausführung „2mm“ entsprechen nicht der RAL-Gütezeichenvorschrift.											
467.1-10		Umlenkungspfeil (Streckenempfehlung) linksweisend	1600 x 2500 (800 x 1250 für Bestätigung)												
467.1-20		Umlenkungspfeil (Streckenempfehlung) rechtsweisend	1600 x 2500 (800 x 1250 für Bestätigung)	-	-	-	-	-	-	-	-	-	1180,00 295,00	1256,00 314,00	1476,00 369,00
467.1-30		Umlenkungspfeil (Streckenempfehlung) geradeaus	2500 x 1600 (1250 x 800 für Bestätigung)												
467.2		Umlenkungspfeil Ende	2500 x 1600												

VERKEHRSZEICHEN

Nr.	Zeichen	Bedeutung	Maße in mm	Flachform 2 mm			Flachform 3 mm			Rundform			Alform				
				Folie RA1	Folie RA2	Folie RA3	Folie RA1	Folie RA2	Folie RA3	Folie RA1	Folie RA2	Folie RA3	Folie RA1	Folie RA2	Folie RA3		
Überleitungstafeln																	
					1600 x 1250												
501-10	501-20	501-11	501-21														
					1600 x 1250												
501-12	501-22	501-13	501-23														
					1600 x 1250												
501-14	501-24	501-15	501-25														
					1600 x 1250												
501-16	501-26	501-17	501-27														
					1600 x 1250	320,00	380,00	476,00	400,00	466,00	564,00	-	-	-	590,00	628,00	738,00
501-18	501-28																
Überleitungstafeln mit Zeichen 264																	
					1600 x 1250												
505-11	505-12	505-21	505-22														
						Schilder der Ausführung „2mm“ entsprechen nicht der RAL-Gütezeichenvorschrift.											
Verschwenkungstafeln																	
					1600 x 1250												
511-10	511-20	511-11	511-21														
					1600 x 1250												
511-12	511-22	511-25	511-26														
					1600 x 1250												
511-27	513-10	513-20	513-11														
					1600 x 1250												
513-21	514-10	514-20															
Verschwenkungstafeln mit Zeichen 264																	
					1600 x 1250												
515-11	515-21	515-12	515-22														

Nr.	Zeichen	Bedeutung	Maße in mm	Flachform 2 mm			Flachform 3 mm			Rundform			Alform				
				Folie RA1	Folie RA2	Folie RA3	Folie RA1	Folie RA2	Folie RA3	Folie RA1	Folie RA2	Folie RA3	Folie RA1	Folie RA2	Folie RA3		
Fahrstreifentafeln																	
					1600 x 1250												
					1600 x 1250												
					1600 x 1250												
					1600 x 1250												
Fahrstreifentafeln mit Zeichen 274																	
					1600 x 1250	320,00	380,00	476,00	400,00	466,00	564,00	-	-	-	590,00	628,00	738,00
Fahrstreifentafeln mit Zeichen 253																	
					1600 x 1250												
Fahrstreifentafeln mit Zeichen 275																	
					1600 x 1250												
Einengungstafeln																	
					1600 x 1250												
					1600 x 1250												
					1600 x 1250												
Trennungstafeln																	
					1600 x 1250												

















VERKEHRSZEICHEN

Nr.	Zeichen	Bedeutung	Maße in mm	Flachform 2 mm			Flachform 3 mm			Rundform			Alform			
				Folie RA1	Folie RA2	Folie RA3	Folie RA1	Folie RA2	Folie RA3	Folie RA1	Folie RA2	Folie RA3	Folie RA1	Folie RA2	Folie RA3	
Einengungstafeln mit Zeichen 279																
					1600 x 1250											
535-11	535-21	536-20	536-21													
Fahrstreifentafeln mit Zeichen 278																
			1600 x 1250													
537-30	537-31															
Aufweitungstafeln																
					1600 x 1250											
541-10	541-11	541-20	541-21													
			1600 x 1250													
542-10	542-11			320,00	380,00	476,00	400,00	466,00	564,00	-	-	-	590,00	628,00	738,00	
				Schilder der Ausführung „2mm“ entsprechen nicht der RAL-Gütezeichenvorschrift.												
Aufweitungstafeln mit Zeichen 275																
				1600 x 1250												
545-11	546-10	546-11														
Zusammenführungstafeln																
					1600 x 1250											
550-20	550-21	550-22	550-23													
					1600 x 1250											
550-24	551-20	551-21	551-22													
			1600 x 1250													
551-23	551-24															
590-10		Blockumfahrung rechts-links-links	600 x 600 840 x 840	59,00 119,00	86,00 164,00	107,00 206,00	83,00 159,00	117,00 213,00	138,00 256,00	89,00 164,00	98,00 178,00	114,00 213,00	109,00 237,00	121,00 261,00	143,00 317,00	
590-11		Blockumfahrung rechts-rechts-rechts	600 x 600 840 x 840													
600-30		Absperrschranke	100 x 800	19,00	25,00	29,00	23,00	30,00	35,00	-	-	-	-	-	-	
600-31			100 x 1200	24,00	32,00	37,00	29,00	39,00	45,00	-	-	-	-	-	-	
600-32			100 x 1600	28,00	38,00	45,00	36,00	47,00	55,00	-	-	-	-	-	-	
600-33			250 x 1200	44,00	61,00	73,00	58,00	77,00	94,00	-	-	-	115,00	124,00	141,00	
600-34			250 x 1600	55,00	76,00	93,00	73,00	99,00	119,00	-	-	-	138,00	150,00	173,00	
600-35			250 x 2000	69,00	95,00	117,00	92,00	123,00	145,00	-	-	-	162,00	177,00	205,00	
600-36			250 x 2400	78,00	111,00	137,00	107,00	145,00	171,00	-	-	-	185,00	203,00	237,00	
600-37			500 x 1600	103,00	147,00	181,00	139,00	192,00	226,00	-	-	-	214,00	243,00	289,00	
600-38			500 x 2000	128,00	178,00	222,00	174,00	233,00	277,00	-	-	-	261,00	289,00	347,00	
600-39			500 x 2400	153,00	213,00	265,00	208,00	280,00	331,00	-	-	-	307,00	341,00	409,00	

Nr.	Zeichen	Bedeutung	Maße in mm	Flachform 2 mm			Flachform 3 mm			Rundform			Alform		
				Folie RA1	Folie RA2	Folie RA3	Folie RA1	Folie RA2	Folie RA3	Folie RA1	Folie RA2	Folie RA3	Folie RA1	Folie RA2	Folie RA3
600-60		Sperrpfosten (Schraffur waagrecht)		Siehe Preisliste „Warn- und Absperrentechnik“ (Katalog Seite 249, Seite 250, Seite 251)											
605-10		Schraffenbake, Aufstellung rechts	1000 x 250	38,00	53,00	63,00	50,00	67,00	79,00	59,00	63,00	72,00	99,00	106,00	122,00
605-20		Schraffenbake, Aufstellung links	1000 x 250												
605-40		Schraffenbake, Aufstellung doppelseitig (-10/-20)	1000 x 250	49,00	72,00	93,00	61,00	87,00	112,00	-	-	-	-	-	-
605-41		Schraffenbake, Aufstellung doppelseitig (-20/-20)	1000 x 250												
605-11		Pfeilbake, Aufstellung rechts	1000 x 250	38,00	53,00	63,00	50,00	67,00	79,00	59,00	63,00	72,00	99,00	106,00	122,00
605-21		Pfeilbake, Aufstellung links	1000 x 250												
605-42		Pfeilbake, Aufstellung doppelseitig (-11/-21)	1000 x 250	49,00	72,00	93,00	61,00	87,00	112,00	-	-	-	-	-	-
605-43		Pfeilbake, Aufstellung doppelseitig (-21/-21)	1000 x 250												
605-12		Warnbake, Aufstellung rechts	2000 x 250	69,00	95,00	117,00	92,00	123,00	145,00	-	-	-	162,00	177,00	205,00
605-22		Warnbake, Aufstellung links	2000 x 250												
605-44		Warnbake, Aufstellung doppelseitig (-12/-22)	2000 x 250	90,00	132,00	174,00	113,00	161,00	205,00	-	-	-	-	-	-
605-45		Warnbake, Aufstellung doppelseitig (-22/-22)	2000 x 250												
605-13		Warnlichtbake, Aufstellung rechts	2500 x 500	Siehe Preisliste „Warn- und Absperrentechnik“ (Katalog Seite 230)											

















VERKEHRSZEICHEN

Nr.	Zeichen	Bedeutung	Maße in mm	Flachform 2 mm			Flachform 3 mm			Rundform			Alform		
				Folie RA1	Folie RA2	Folie RA3	Folie RA1	Folie RA2	Folie RA3	Folie RA1	Folie RA2	Folie RA3	Folie RA1	Folie RA2	Folie RA3
605-23		Warnlichtbake, Aufstellung links	2500 x 500	Siehe Preisliste „Warn- und Absperrentechnik“ (Katalog Seite 230)											
605-14		Warnlichtbake Aufstellung rechts, mit Z. 222-10	2500 x 500												
605-24		Warnlichtbake Aufstellung links, m. Z. 222	2500 x 500												
610-40		Leitkegel Größe = 300 41: Größe = 500 42: Größe = 750 43: Größe = 1000	Ausführung nach TL-Leitkegel	Siehe Preisliste „Warn- und Absperrentechnik“ (Katalog Seite 232)											
615		Fahrbare Absperrtafel	2500 x 1700	Preise auf Anfrage Es handelt sich hier nur um die Beplankung für den Absperrhänger. Anhänger auf Anfrage erhältlich.											
616-30		Fahrbare Absperrtafel mit Blinkpfeil große Ausführung	3600 x 2200												
616-31		Fahrbare Absperrtafel mit Blinkpfeil kleine Ausführung	2500 x 1700												
625-10		Richtungstafel in Kurven, linksweisend	500 x 500	36,00	49,00	60,00	50,00	66,00	78,00	56,00	59,00	67,00	84,00	90,00	106,00
625-11		Richtungstafel	500 x 1500	97,00	139,00	171,00	131,00	181,00	213,00	-	-	-	204,00	231,00	274,00
625-12		in Kurven,	500 x 2000	128,00	178,00	222,00	174,00	233,00	277,00	-	-	-	261,00	289,00	347,00
625-13		linksweisend	500 x 2500	161,00	225,00	275,00	218,00	294,00	347,00	-	-	-	391,00	432,00	502,00
				Die Ausführung „2mm“ entspricht in der Größe 500 x 2500 nicht der RAL-Gütezeichenvorschrift.											
625-20		Richtungstafel in Kurven, rechtsweisend	500 x 500	36,00	49,00	60,00	50,00	66,00	78,00	56,00	59,00	67,00	84,00	90,00	106,00
625-21		Richtungstafel	500 x 1500	97,00	139,00	171,00	131,00	181,00	213,00	-	-	-	204,00	231,00	274,00
625-22		in Kurven,	500 x 2000	128,00	178,00	222,00	174,00	233,00	277,00	-	-	-	261,00	289,00	347,00
625-23		rechtsweisend	500 x 2500	161,00	225,00	275,00	218,00	294,00	347,00	-	-	-	391,00	432,00	502,00
				Die Ausführung „2mm“ entspricht in der Größe 500 x 2500 nicht der RAL-Gütezeichenvorschrift.											
626-10		Leitplatte Aufstellung rechts	750 x 500	53,00 73,00 89,00 70,00 93,00 111,00 82,00 88,00 102,00 114,00 125,00 149,00											
626-20		Leitplatte, Aufstellung links	750 x 500												
626-30		Leitplatte, beidseitig vorbei	750 x 500	53,00	73,00	89,00	70,00	93,00	111,00	82,00	88,00	102,00	114,00	125,00	149,00
626-31		1200 x 600	93,00	131,00	162,00	126,00	171,00	202,00	-	-	-	194,00	218,00	258,00	
626-32		2500 x 500	161,00	225,00	275,00	218,00	294,00	347,00	-	-	-	391,00	432,00	502,00	
				Die Ausführung „2mm“ entspricht in der Größe 500 x 2500 nicht der RAL-Gütezeichenvorschrift.											

















Nr.	Zeichen	Bedeutung	Maße in mm	Flachform 2 mm			Flachform 3 mm			Rundform			Alform			
				Folie RA1	Folie RA2	Folie RA3	Folie RA1	Folie RA2	Folie RA3	Folie RA1	Folie RA2	Folie RA3	Folie RA1	Folie RA2	Folie RA3	
627-10		Leitmal, Anbringung rechts (senkrecht)	Breite 250 lfd. m													
627-20		Leitmal, Anbringung links (senkrecht)	Breite 250 lfd. m	-	53,00	63,00	-	67,00	79,00	-	-	-	-	-	-	-
627-30		Leitmal waagrecht (Abbildung entspricht einem Leitmal in 2m Breite)	Höhe 250 lfd. m													
627-50		Leitmal gebogen	Breite 250 lfd. m	-	128,00	146,00	-	149,00	168,00	-	-	-	-	-	-	-
628-10		Leitschwelle mit Leitbake, Aufstellung rechts (mit 605-10)	Ausführung nach RSA	Siehe Preisliste „Warn- und Absperrentechnik“ (Katalog Seite 243)												
628-40		Leitschwelle mit Leitbake, Aufstellung doppelseitig (mit 605-40)	Ausführung nach RSA													
628-11		Leitschwelle mit Leitbake, Aufstellung rechts (mit 605-11)	Ausführung nach RSA													
628-42		Leitschwelle mit Leitbake, Aufstellung doppelseitig (mit 605-42)	Ausführung nach RSA													
628-20		Leitschwelle mit Leitbake, Aufst. links (mit 605-20)	Ausführung nach RSA													
628-41		Leitschwelle mit Leitbake, Aufst. doppelseitig (mit 605-41)	Ausführung nach RSA													
628-21		Leitschwelle mit Leitbake, Aufstellung links (mit 605-21)	Ausführung nach RSA													
628-43		Leitschwelle m. Leitbake, Aufstellung doppelseitig (mit 605-43)	Ausführung nach RSA													
629-10		Leitbord m. Leitbake, Aufstellung rechts (mit 605-10)	Ausführung nach RSA													
629-40		Leitbord m. Leitbake, Aufstellung doppelseitig (mit 605-40)	Ausführung nach RSA													
629-11		Leitbord m. Leitbake, Aufstellung rechts (mit 605-11)	Ausführung nach RSA													
629-42		Leitbord m. Leitbake, Aufstellung doppelseitig (mit 605-42)	Ausführung nach RSA													

















VERKEHRSZEICHEN

Nr.	Zeichen	Bedeutung	Maße in mm	Flachform 2 mm			Flachform 3 mm			Rundform			Alform		
				Folie RA1	Folie RA2	Folie RA3	Folie RA1	Folie RA2	Folie RA3	Folie RA1	Folie RA2	Folie RA3	Folie RA1	Folie RA2	Folie RA3
629-20		Leitbord m. Leitbake, Aufstellung links (mit 605-20)	Ausführung nach RSA	Siehe Preisliste „Warn- und Absperrentechnik“ (Katalog Seite 243)											
629-41		Leitbord m. Leitbake, Aufstellung doppel-seitig (mit 605-41)	Ausführung nach RSA												
629-21		Leitbord m. Pfeilbake, Aufstellung links (mit 605-21)	Ausführung nach RSA												
629-43		Leitbord m. Pfeilbake, Aufstellung doppel-seitig (mit 605-43)	Ausführung nach RSA												
630-10		Parkwarntafel links vorbei	423 x 423	Siehe Preisliste „Straßen- und Warnmarkierung“ (Katalog Seite 225)											
630-20		Parkwarntafel rechts vorbei	423 x 423												
720		Grünpfeilschild	250 x 250 lackiert	27,00	-	-	-	-	-	-	-	-	-	-	-
1000-10		Richtung, linksweisend	231 x 420 330 x 600 412 x 750	21,00 29,00 33,00 27,00 37,00 41,00 38,00 42,00 45,00 44,00 48,00 52,00 30,00 43,00 50,00 42,00 58,00 65,00 53,00 56,00 60,00 61,00 66,00 74,00 48,00 65,00 78,00 62,00 83,00 96,00 80,00 84,00 95,00 105,00 115,00 132,00											
1000-20		Richtung, rechtsweisend	231 x 420 330 x 600 412 x 750												
1000-11		Richtung der Gefahr-stelle, linksweisend	231 x 420 330 x 600 412 x 750												
1000-21		Richtung der Gefahr-stelle, rechtsweisend	231 x 420 330 x 600 412 x 750												
1000-12		Fußgänger Gehweg gegenüber benutzen, linksweisend	231 x 420 330 x 600												
1000-22		Fußgänger Gehweg gegenüber benutzen, rechtsweisend	231 x 420 330 x 600												
1000-13		Umleitungsbeschilderung Dreiviertelkreis	315 x 420 450 x 600	31,00 48,00	42,00 69,00	46,00 85,00	42,00 67,00	55,00 93,00	59,00 110,00	64,00 90,00	67,00 95,00	72,00 105,00	64,00 92,00	68,00 100,00	72,00 118,00
1000-23		Umleitungsbeschilderung Viertelkreis	231 x 420 330 x 600	26,00 38,00	36,00 54,00	41,00 63,00	34,00 53,00	46,00 72,00	51,00 81,00	48,00 66,00	52,00 70,00	56,00 75,00	55,00 77,00	60,00 83,00	65,00 92,00
1000-30		Beide Richtungen, zwei gegengerichtete waagerechte Pfeile	231 x 420 330 x 600	21,00 30,00	29,00 43,00	33,00 50,00	27,00 42,00	37,00 58,00	41,00 65,00	38,00 53,00	42,00 56,00	45,00 60,00	44,00 61,00	48,00 66,00	52,00 74,00

















Nr.	Zeichen	Bedeutung	Maße in mm	Flachform 2 mm			Flachform 3 mm			Rundform			Alform		
				Folie RA1	Folie RA2	Folie RA3	Folie RA1	Folie RA2	Folie RA3	Folie RA1	Folie RA2	Folie RA3	Folie RA1	Folie RA2	Folie RA3
1000-31		Beide Richtungen, zwei gegengerichtete senkrechte Pfeile	231 x 420 330 x 600	21,00 30,00	29,00 43,00	33,00 50,00	27,00 42,00	37,00 58,00	41,00 65,00	38,00 53,00	42,00 56,00	45,00 60,00	44,00 61,00	48,00 66,00	52,00 74,00
1000-32		Radverkehr kreuzt von links und rechts	315 x 420 450 x 600	25,00 39,00	34,00 55,00	37,00 68,00	34,00 54,00	44,00 74,00	47,00 88,00	52,00 72,00	54,00 76,00	58,00 84,00	51,00 74,00	55,00 80,00	58,00 94,00
1000-34		Umleitungsbeschilderung Halbkreis	420 x 420 600 x 600	39,00 59,00	53,00 86,00	63,00 107,00	50,00 83,00	67,00 117,00	76,00 138,00	70,00 89,00	76,00 98,00	82,00 114,00	75,00 109,00	81,00 121,00	92,00 143,00
1001-30		auf ... m	231 x 420 330 x 600 412 x 750	26,00 38,00 59,00	36,00 54,00 81,00	41,00 63,00 97,00	34,00 53,00 77,00	46,00 72,00 103,00	51,00 81,00 119,00	48,00 66,00 100,00	52,00 70,00 105,00	56,00 75,00 118,00	55,00 77,00 132,00	60,00 83,00 143,00	65,00 92,00 165,00
1001-31		auf ... km	231 x 420 330 x 600 412 x 750												
1001-32		noch ... m (gemäß VwV-StVO in Tunneln)	315 x 420 450 x 600	31,00 48,00	42,00 69,00	46,00 85,00	42,00 67,00	55,00 93,00	59,00 110,00	64,00 90,00	67,00 95,00	72,00 105,00	64,00 92,00	68,00 100,00	72,00 118,00
1001-33		noch ... km (gemäß VwV-StVO in Tunneln)	315 x 420 450 x 600												
1001-34		auf ... m (verbal) (in Verbindung mit Fahrstreifentafeln Z. 521 ff.)	500 x 1250	101,00	147,00	180,00	136,00	190,00	224,00	-	-	-	217,00	249,00	294,00
1001-35		auf ... km (verbal) (in Verbindung mit Fahrstreifentafeln Z. 521 ff.)	500 x 1250												
1002-10		Verlauf der Vorfahrtsstraße	420 x 420 600 x 600												
1002-11		Verlauf der Vorfahrtsstraße	420 x 420 600 x 600												
1002-12		Verlauf der Vorfahrtsstraße	420 x 420 600 x 600	31,00 48,00	43,00 69,00	51,00 86,00	40,00 67,00	53,00 93,00	61,00 110,00	56,00 71,00	61,00 78,00	66,00 91,00	60,00 87,00	65,00 97,00	73,00 114,00
1002-13		Verlauf der Vorfahrtsstraße	420 x 420 600 x 600												
1002-14		Verlauf der Vorfahrtsstraße	420 x 420 600 x 600												
1002-20		Verlauf der Vorfahrtsstraße	420 x 420 600 x 600												
1002-21		Verlauf der Vorfahrtsstraße	420 x 420 600 x 600												

















VERKEHRSZEICHEN

Nr.	Zeichen	Bedeutung	Maße in mm	Flachform 2 mm			Flachform 3 mm			Rundform			Alform		
				Folie RA1	Folie RA2	Folie RA3	Folie RA1	Folie RA2	Folie RA3	Folie RA1	Folie RA2	Folie RA3	Folie RA1	Folie RA2	Folie RA3
1002-22		Verlauf der Vorfahrtsstraße	420 x 420 600 x 600												
1002-23		Verlauf der Vorfahrtsstraße	420 x 420 600 x 600	31,00 48,00	43,00 69,00	51,00 86,00	40,00 67,00	53,00 93,00	61,00 110,00	56,00 71,00	61,00 78,00	66,00 91,00	60,00 87,00	65,00 97,00	73,00 114,00
1002-24		Verlauf der Vorfahrtsstraße	420 x 420 600 x 600												
1004-30		Entfernungsangabe in m (nur volle 50er)	231 x 420 330 x 600 412 x 750	21,00 30,00 48,00	29,00 43,00 65,00	33,00 50,00 78,00	27,00 42,00 62,00	37,00 58,00 83,00	41,00 65,00 96,00	38,00 53,00 80,00	42,00 56,00 84,00	45,00 60,00 95,00	44,00 61,00 105,00	48,00 66,00 115,00	52,00 74,00 132,00
1004-31		Entfernungsangabe in ... km	231 x 420 330 x 600 412 x 750												
1004-32		Stop in ... m	315 x 420 450 x 600 562 x 750	25,00 39,00 62,00	34,00 55,00 84,00	37,00 68,00 102,00	34,00 54,00 81,00	44,00 74,00 108,00	47,00 88,00 126,00	52,00 72,00 95,00	54,00 76,00 102,00	58,00 84,00 116,00	51,00 74,00 130,00	55,00 80,00 142,00	58,00 94,00 166,00
1005-30		Reißverschluss erst in ... m	500 x 1250	101,00	147,00	180,00	136,00	190,00	224,00	-	-	-	217,00	249,00	294,00
1006-30		Schleudergefahr für Wohnwagengespanne an Gefällestrassen mit starkem Seitenwind auf Autobahnen	330 x 600 412 x 750	38,00 59,00	54,00 81,00	63,00 97,00	53,00 77,00	72,00 103,00	81,00 119,00	66,00 100,00	70,00 105,00	75,00 118,00	77,00 132,00	83,00 143,00	92,00 165,00
1006-31		Unfallgefahr	231 x 420 330 x 600 412 x 750	26,00 38,00 59,00	36,00 54,00 81,00	41,00 63,00 97,00	34,00 53,00 77,00	46,00 72,00 103,00	51,00 81,00 119,00	48,00 66,00 100,00	52,00 70,00 105,00	56,00 75,00 118,00	55,00 77,00 132,00	60,00 83,00 143,00	65,00 92,00 165,00
1007-30		Ölspur	231 x 420 330 x 600 412 x 750	21,00 30,00 48,00	29,00 43,00 65,00	33,00 50,00 78,00	27,00 42,00 62,00	37,00 58,00 83,00	41,00 65,00 96,00	38,00 53,00 80,00	42,00 56,00 84,00	45,00 60,00 95,00	44,00 61,00 105,00	48,00 66,00 115,00	52,00 74,00 132,00
1007-31		Rauch	231 x 420 330 x 600 412 x 750	26,00 38,00 59,00	36,00 54,00 81,00	41,00 63,00 97,00	34,00 53,00 77,00	46,00 72,00 103,00	51,00 81,00 119,00	48,00 66,00 100,00	52,00 70,00 105,00	56,00 75,00 118,00	55,00 77,00 132,00	60,00 83,00 143,00	65,00 92,00 165,00
1007-32		Rollsplitt	231 x 420 330 x 600 412 x 750												
1007-33		Baustellenausfahrt	231 x 420 330 x 600 412 x 750	21,00 30,00 48,00	29,00 43,00 65,00	33,00 50,00 78,00	27,00 42,00 62,00	37,00 58,00 83,00	41,00 65,00 96,00	38,00 53,00 80,00	42,00 56,00 84,00	45,00 60,00 95,00	44,00 61,00 105,00	48,00 66,00 115,00	52,00 74,00 132,00
1007-34		Straßenschäden	231 x 420 330 x 600 412 x 750												
1007-35		Verschmutzte Fahrbahn	231 x 420 330 x 600 412 x 750												
1007-36		Sprengarbeiten	231 x 420 330 x 600 412 x 750	26,00 38,00 59,00	36,00 54,00 81,00	41,00 63,00 97,00	34,00 53,00 77,00	46,00 72,00 103,00	51,00 81,00 119,00	48,00 66,00 100,00	52,00 70,00 105,00	56,00 75,00 118,00	55,00 77,00 132,00	60,00 83,00 143,00	65,00 92,00 165,00

Nr.	Zeichen	Bedeutung	Maße in mm	Flachform 2 mm			Flachform 3 mm			Rundform			Alform		
				Folie RA1	Folie RA2	Folie RA3	Folie RA1	Folie RA2	Folie RA3	Folie RA1	Folie RA2	Folie RA3	Folie RA1	Folie RA2	Folie RA3
1007-37		Ausfahrt	231 x 420 330 x 600 412 x 750	26,00 38,00 59,00	36,00 54,00 81,00	41,00 63,00 97,00	34,00 53,00 77,00	46,00 72,00 103,00	51,00 81,00 119,00	48,00 66,00 100,00	52,00 70,00 105,00	56,00 75,00 118,00	55,00 77,00 132,00	60,00 83,00 143,00	65,00 92,00 165,00
1007-38		Baustellenverkehr	231 x 420 330 x 600 412 x 750	21,00 30,00 48,00	29,00 43,00 65,00	33,00 50,00 78,00	27,00 42,00 62,00	37,00 58,00 83,00	41,00 65,00 96,00	38,00 53,00 80,00	42,00 56,00 84,00	45,00 60,00 95,00	44,00 61,00 105,00	48,00 66,00 115,00	52,00 74,00 132,00
1007-39		fehlende Fahrbahnmarkierung	315 x 420 450 x 600 562 x 750	31,00 48,00 77,00	42,00 69,00 105,00	46,00 85,00 128,00	42,00 67,00 101,00	55,00 93,00 135,00	59,00 110,00 158,00	64,00 90,00 119,00	67,00 95,00 127,00	72,00 105,00 145,00	64,00 92,00 163,00	68,00 100,00 178,00	72,00 118,00 207,00
1007-50		Unfall	231 x 420 330 x 600 412 x 750	26,00 38,00 59,00	36,00 54,00 81,00	41,00 63,00 97,00	34,00 53,00 77,00	46,00 72,00 103,00	51,00 81,00 119,00	48,00 66,00 100,00	52,00 70,00 105,00	56,00 75,00 118,00	55,00 77,00 132,00	60,00 83,00 143,00	65,00 92,00 165,00
1007-51		Hochwasser	231 x 420 330 x 600 412 x 750	21,00 30,00 48,00	29,00 43,00 65,00	33,00 50,00 78,00	27,00 42,00 62,00	37,00 58,00 83,00	41,00 65,00 96,00	38,00 53,00 80,00	42,00 56,00 84,00	45,00 60,00 95,00	44,00 61,00 105,00	48,00 66,00 115,00	52,00 74,00 132,00
1007-52		neuer Fahrbahnbelag	315 x 420 450 x 600 562 x 750	31,00 48,00 77,00	42,00 69,00 105,00	46,00 85,00 128,00	42,00 67,00 101,00	55,00 93,00 135,00	59,00 110,00 158,00	64,00 90,00 119,00	67,00 95,00 127,00	72,00 105,00 145,00	64,00 92,00 163,00	68,00 100,00 178,00	72,00 118,00 207,00
1007-53		Spurrinnen	231 x 420 330 x 600 412 x 750	21,00 30,00 48,00	29,00 43,00 65,00	33,00 50,00 78,00	27,00 42,00 62,00	37,00 58,00 83,00	41,00 65,00 96,00	38,00 53,00 80,00	42,00 56,00 84,00	45,00 60,00 95,00	44,00 61,00 105,00	48,00 66,00 115,00	52,00 74,00 132,00
1007-54		Linksabbieger	231 x 420 330 x 600												
1007-55		Skiabfahrt kreuzt	231 x 420 330 x 600	26,00 38,00	36,00 54,00	41,00 63,00	34,00 53,00	46,00 72,00	51,00 81,00	48,00 66,00	52,00 70,00	56,00 75,00	55,00 77,00	60,00 83,00	65,00 92,00
1007-56		Skiwanderweg kreuzt	231 x 420 330 x 600												
1007-57		Kuppe	231 x 420 330 x 600 412 x 750	26,00 38,00 59,00	36,00 54,00 81,00	41,00 63,00 97,00	34,00 53,00 77,00	46,00 72,00 103,00	51,00 81,00 119,00	48,00 66,00 100,00	52,00 70,00 105,00	56,00 75,00 118,00	55,00 77,00 132,00	60,00 83,00 143,00	65,00 92,00 165,00
1007-58		Polizeikontrolle	231 x 420 330 x 600 412 x 750												
1007-59		Ende Seitenstreifen in 200 m	450 x 600 562 x 750	48,00 77,00	69,00 105,00	85,00 128,00	67,00 101,00	93,00 135,00	110,00 158,00	90,00 119,00	95,00 127,00	105,00 145,00	92,00 163,00	100,00 178,00	118,00 207,00
1007-60		Seitenstreifen nicht befahrbar	315 x 420 450 x 600 562 x 750	25,00 39,00 62,00	34,00 55,00 84,00	37,00 68,00 102,00	34,00 54,00 81,00	44,00 74,00 108,00	47,00 88,00 126,00	52,00 72,00 95,00	54,00 76,00 102,00	58,00 84,00 116,00	51,00 74,00 130,00	55,00 80,00 142,00	58,00 94,00 166,00
1007-61		Nebel	Ausführung nach RWVZ 1997	Preise auf Anfrage											
1007-62		Zufahrt	231 x 420 330 x 600	26,00 38,00	36,00 54,00	41,00 63,00	34,00 53,00	46,00 72,00	51,00 81,00	48,00 66,00	52,00 70,00	56,00 75,00	55,00 77,00	60,00 83,00	65,00 92,00

















VERKEHRSZEICHEN

Nr.	Zeichen	Bedeutung	Maße in mm	Flachform 2 mm			Flachform 3 mm			Rundform			Alform		
				Folie RA1	Folie RA2	Folie RA3	Folie RA1	Folie RA2	Folie RA3	Folie RA1	Folie RA2	Folie RA3	Folie RA1	Folie RA2	Folie RA3
1008-30		Vorfahrt geändert	231 x 420 330 x 600	21,00 30,00	29,00 43,00	33,00 50,00	27,00 42,00	37,00 58,00	41,00 65,00	38,00 53,00	42,00 56,00	45,00 60,00	44,00 61,00	48,00 66,00	52,00 74,00
1008-31		Verkehrsführung geändert	315 x 420 450 x 600	25,00 39,00	34,00 55,00	37,00 68,00	34,00 54,00	44,00 74,00	47,00 88,00	52,00 72,00	54,00 76,00	58,00 84,00	51,00 74,00	55,00 80,00	58,00 94,00
1008-32		Industriegebiet Schienenfahrzeuge haben Vorrang (zu Z. 201)	450 x 600	48,00	69,00	85,00	67,00	93,00	110,00	90,00	95,00	105,00	92,00	100,00	118,00
1008-33		Hafengebiet Schienenfahrzeuge haben Vorrang (zu Z. 201)	450 x 600												
1008-34		keine Wende- möglichkeit	231 x 420 330 x 600	21,00 30,00	29,00 43,00	33,00 50,00	27,00 42,00	37,00 58,00	41,00 65,00	38,00 53,00	42,00 56,00	45,00 60,00	44,00 61,00	48,00 66,00	52,00 74,00
1010-10		erlaubt Kindern auch auf der Fahrbahn und dem Seiten- streifen zu spielen	231 x 420 330 x 600												
1010-11		Wintersport erlaubt	231 x 420 330 x 600	26,00 38,00	36,00 54,00	41,00 63,00	34,00 53,00	46,00 72,00	51,00 81,00	48,00 66,00	52,00 70,00	56,00 75,00	55,00 77,00	60,00 83,00	65,00 92,00
1010-12		Kennzeichnung von Parkflächen, auf denen Anhänger auch länger als 14 Tage parken dürfen	231 x 420 330 x 600												
1010-13		Kennzeichnung von Parkflächen, auf denen Wohnwagen auch länger als 14 Tage parken dürfen	231 x 420 330 x 600												
1010-14		Information Rollende Landstraße	330 x 600 412 x 750	38,00 59,00	54,00 81,00	63,00 97,00	53,00 77,00	72,00 103,00	81,00 119,00	66,00 100,00	70,00 105,00	75,00 118,00	77,00 132,00	83,00 143,00	92,00 165,00
1010-15		Information Leistungsumfang (zu Z 448.1)	Ausführung nach RWBA	Preise auf Anfrage											
1010-50		Kraftwagen und sonstige mehrspurige Fahrzeuge	231 x 420 330 x 600 412 x 750	26,00 38,00 59,00	36,00 54,00 81,00	41,00 63,00 97,00	34,00 53,00 77,00	46,00 72,00 103,00	51,00 81,00 119,00	48,00 66,00 100,00	52,00 70,00 105,00	56,00 75,00 118,00	55,00 77,00 132,00	60,00 83,00 143,00	65,00 92,00 165,00
1010-51		Kraftfahrzeuge mit einer zulässigen Gesamtmasse über 3,5 t, einschl. ihrer Anhänger, und Zugma- schinen, ausgen. Pkw und Kraftomnibusse	231 x 420 330 x 600 412 x 750	21,00 30,00 48,00	29,00 43,00 65,00	33,00 50,00 78,00	27,00 42,00 62,00	37,00 58,00 83,00	41,00 65,00 96,00	38,00 53,00 80,00	42,00 56,00 84,00	45,00 60,00 95,00	44,00 61,00 105,00	48,00 66,00 115,00	52,00 74,00 132,00
1010-52		Radverkehr	231 x 420 330 x 600												
1010-53		Fußgänger	231 x 420 330 x 600	26,00 38,00	36,00 54,00	41,00 63,00	34,00 53,00	46,00 72,00	51,00 81,00	48,00 66,00	52,00 70,00	56,00 75,00	55,00 77,00	60,00 83,00	65,00 92,00
1010-54		Reiter	231 x 420 330 x 600												

















Nr.	Zeichen	Bedeutung	Maße in mm	Flachform 2 mm			Flachform 3 mm			Rundform			Alform		
				Folie RA1	Folie RA2	Folie RA3	Folie RA1	Folie RA2	Folie RA3	Folie RA1	Folie RA2	Folie RA3	Folie RA1	Folie RA2	Folie RA3
1010-55		Viehtrieb	231 x 420 330 x 600	26,00 38,00	36,00 54,00	41,00 63,00	34,00 53,00	46,00 72,00	51,00 81,00	48,00 66,00	52,00 70,00	56,00 75,00	55,00 77,00	60,00 83,00	65,00 92,00
1010-56		Straßenbahn	231 x 420 330 x 600	21,00 30,00	29,00 43,00	33,00 50,00	27,00 42,00	37,00 58,00	41,00 65,00	38,00 53,00	42,00 56,00	45,00 60,00	44,00 61,00	48,00 66,00	52,00 74,00
1010-57		Kraftomnibus	231 x 420 330 x 600 412 x 750	21,00 30,00 48,00	29,00 43,00 65,00	33,00 50,00 78,00	27,00 42,00 62,00	37,00 58,00 83,00	41,00 65,00 96,00	38,00 53,00 80,00	42,00 56,00 84,00	45,00 60,00 95,00	44,00 61,00 105,00	48,00 66,00 115,00	52,00 74,00 132,00
1010-58		Personenkraftwagen	231 x 420 330 x 600 412 x 750												
1010-59		Personenkraftwagen mit Anhänger	231 x 420 330 x 600 412 x 750	26,00 38,00 59,00	36,00 54,00 81,00	41,00 63,00 97,00	34,00 53,00 77,00	46,00 72,00 103,00	51,00 81,00 119,00	48,00 66,00 100,00	52,00 70,00 105,00	56,00 75,00 118,00	55,00 77,00 132,00	60,00 83,00 143,00	65,00 92,00 165,00
1010-60		Lastkraftwagen mit Anhänger	231 x 420 330 x 600 412 x 750												
1010-61		Kraftfahrzeuge und Züge, die nicht schneller als 25 km/h fahren können oder dürfen	231 x 420 330 x 600	26,00 38,00	36,00 54,00	41,00 63,00	34,00 53,00	46,00 72,00	51,00 81,00	48,00 66,00	52,00 70,00	56,00 75,00	55,00 77,00	60,00 83,00	65,00 92,00
1010-62		Krafträder, auch mit Beiwagen, Kleinkrafträder und Mofas	231 x 420 330 x 600 412 x 750	21,00 30,00 48,00	29,00 43,00 65,00	33,00 50,00 78,00	27,00 42,00 62,00	37,00 58,00 83,00	41,00 65,00 96,00	38,00 53,00 80,00	42,00 56,00 84,00	45,00 60,00 95,00	44,00 61,00 105,00	48,00 66,00 115,00	52,00 74,00 132,00
1010-63		Mofas	231 x 420 330 x 600												
1010-64		Gespannfuhrwerke	231 x 420 330 x 600	26,00 38,00	36,00 54,00	41,00 63,00	34,00 53,00	46,00 72,00	51,00 81,00	48,00 66,00	52,00 70,00	56,00 75,00	55,00 77,00	60,00 83,00	65,00 92,00
1010-65		E-Bikes	231 x 420 330 x 600												
1010-66		Elektrisch betriebene Fahrzeuge	231 x 420 330 x 600 412 x 750	26,00 38,00 59,00	36,00 54,00 81,00	41,00 63,00 97,00	34,00 53,00 77,00	46,00 72,00 103,00	51,00 81,00 119,00	48,00 66,00 100,00	52,00 70,00 105,00	56,00 75,00 118,00	55,00 77,00 132,00	60,00 83,00 143,00	65,00 92,00 165,00
1010-67		Wohnmobile	231 x 420 330 x 600 412 x 750												
1012-30		Ladezone	231 x 420 330 x 600	26,00 38,00	36,00 54,00	41,00 63,00	34,00 53,00	46,00 72,00	51,00 81,00	48,00 66,00	52,00 70,00	56,00 75,00	55,00 77,00	60,00 83,00	65,00 92,00
1012-31		Ende	231 x 420 330 x 600 412 x 750	21,00 30,00 48,00	29,00 43,00 65,00	33,00 50,00 78,00	27,00 42,00 62,00	37,00 58,00 83,00	41,00 65,00 96,00	38,00 53,00 80,00	42,00 56,00 84,00	45,00 60,00 95,00	44,00 61,00 105,00	48,00 66,00 115,00	52,00 74,00 132,00
1012-32		Radfahrer absteigen	231 x 420 330 x 600	21,00 30,00	29,00 43,00	33,00 50,00	27,00 42,00	37,00 58,00	41,00 65,00	38,00 53,00	42,00 56,00	45,00 60,00	44,00 61,00	48,00 66,00	52,00 74,00

















VERKEHRSZEICHEN

Nr.	Zeichen	Bedeutung	Maße in mm	Flachform 2 mm			Flachform 3 mm			Rundform			Alform		
				Folie RA1	Folie RA2	Folie RA3	Folie RA1	Folie RA2	Folie RA3	Folie RA1	Folie RA2	Folie RA3	Folie RA1	Folie RA2	Folie RA3
1012-33		Keine Mofas	231 x 420 330 x 600	26,00 38,00	36,00 54,00	41,00 63,00	34,00 53,00	46,00 72,00	51,00 81,00	48,00 66,00	52,00 70,00	56,00 75,00	55,00 77,00	60,00 83,00	65,00 92,00
1012-34		Grüne Welle bei ... km/h	231 x 420 330 x 600												
1012-35		Bei Rot hier halten	231 x 420 330 x 600	21,00 30,00	29,00 43,00	33,00 50,00	27,00 42,00	37,00 58,00	41,00 65,00	38,00 53,00	42,00 56,00	45,00 60,00	44,00 61,00	48,00 66,00	52,00 74,00
1012-36		Lärmschutz	231 x 420 330 x 600 412 x 750	26,00 38,00 59,00	36,00 54,00 81,00	41,00 63,00 97,00	34,00 53,00 77,00	46,00 72,00 103,00	51,00 81,00 119,00	48,00 66,00 100,00	52,00 70,00 105,00	56,00 75,00 118,00	55,00 77,00 132,00	60,00 83,00 143,00	65,00 92,00 165,00
1012-37		Zuflussregelung	231 x 420 330 x 600 412 x 750												
1012-38		Nebenstrecke	Ausführung nach RUB	Preise auf Anfrage											
1012-50		Schule	231 x 420 330 x 600												
1012-51		Kindergarten	231 x 420 330 x 600	26,00 38,00	36,00 54,00	41,00 63,00	34,00 53,00	46,00 72,00	51,00 81,00	48,00 66,00	52,00 70,00	56,00 75,00	55,00 77,00	60,00 83,00	65,00 92,00
1012-52		Altenheim	231 x 420 330 x 600												
1012-53		Krankenhaus	231 x 420 330 x 600												
1013-50		Seitenstreifen befahren	800 x 2250	-	-	-	377,00	510,00	605,00	-	-	-	531,00	566,00	665,00
1013-51		Seitenstreifen räumen	800 x 2250												
1013-52		Ende in ... m	500 x 2250	-	-	-	245,00	329,00	390,00	-	-	-	332,00	354,00	416,00
1014-50		Tunnelkategorie „B“ gemäß ADR-Übereinkommen 1014-51: ... „C“ ... 1014-52: ... „D“ ... 1014-53: ... „E“ ...	231 x 420 330 x 600 412 x 750	26,00 38,00 59,00	36,00 54,00 81,00	41,00 63,00 97,00	34,00 53,00 77,00	46,00 72,00 103,00	51,00 81,00 119,00	48,00 66,00 100,00	52,00 70,00 105,00	56,00 75,00 118,00	55,00 77,00 132,00	60,00 83,00 143,00	65,00 92,00 165,00
1020-11		Schwerbehinderte mit Parkausweis Nr. ... frei	231 x 420 330 x 600	21,00 30,00	29,00 43,00	33,00 50,00	27,00 42,00	37,00 58,00	41,00 65,00	38,00 53,00	42,00 56,00	45,00 60,00	44,00 61,00	48,00 66,00	52,00 74,00
1020-12		Radverkehr und Anlieger frei	315 x 420 450 x 600	25,00 39,00	34,00 55,00	37,00 68,00	34,00 54,00	44,00 74,00	47,00 88,00	52,00 72,00	54,00 76,00	58,00 84,00	51,00 74,00	55,00 80,00	58,00 94,00

















Nr.	Zeichen	Bedeutung	Maße in mm	Flachform 2 mm			Flachform 3 mm			Rundform			Alform		
				Folie RA1	Folie RA2	Folie RA3	Folie RA1	Folie RA2	Folie RA3	Folie RA1	Folie RA2	Folie RA3	Folie RA1	Folie RA2	Folie RA3
1020-13	 frei	Inline-Skaten und Rollschuhfahren frei	231 x 420 330 x 600	26,00 38,00	36,00 54,00	41,00 63,00	34,00 53,00	46,00 72,00	51,00 81,00	48,00 66,00	52,00 70,00	56,00 75,00	55,00 77,00	60,00 83,00	65,00 92,00
1020-14	 frei	Wintersport frei	231 x 420 330 x 600												
1020-30	 frei	Anlieger frei	231 x 420 330 x 600	21,00 30,00	29,00 43,00	33,00 50,00	27,00 42,00	37,00 58,00	41,00 65,00	38,00 53,00	42,00 56,00	45,00 60,00	44,00 61,00	48,00 66,00	52,00 74,00
1020-31	 frei	Anlieger oder Parken frei	315 x 420 450 x 600	31,00 48,00	42,00 69,00	46,00 85,00	42,00 67,00	55,00 93,00	59,00 110,00	64,00 90,00	67,00 95,00	72,00 105,00	64,00 92,00	68,00 100,00	72,00 118,00
1020-32	 frei	Bewohner mit Parkausweis Nr. ... frei	231 x 420 330 x 600	21,00 30,00	29,00 43,00	33,00 50,00	27,00 42,00	37,00 58,00	41,00 65,00	38,00 53,00	42,00 56,00	45,00 60,00	44,00 61,00	48,00 66,00	52,00 74,00
1022-10	 frei	Radverkehr frei	315 x 420 450 x 600	25,00 39,00	34,00 55,00	37,00 68,00	34,00 54,00	44,00 74,00	47,00 88,00	52,00 72,00	54,00 76,00	58,00 84,00	51,00 74,00	55,00 80,00	58,00 94,00
1022-11	 frei	Mofas frei	315 x 420 450 x 600	31,00 48,00	42,00 69,00	46,00 85,00	42,00 67,00	55,00 93,00	59,00 110,00	64,00 90,00	67,00 95,00	72,00 105,00	64,00 92,00	68,00 100,00	72,00 118,00
1022-12	 frei	Krafträder, auch mit Beiwagen, Kleinkrafträder und Mofas frei	315 x 420 450 x 600	25,00 39,00	34,00 55,00	37,00 68,00	34,00 54,00	44,00 74,00	47,00 88,00	52,00 72,00	54,00 76,00	58,00 84,00	51,00 74,00	55,00 80,00	58,00 94,00
1022-13	 frei	E-Bikes frei	315 x 420 450 x 600	31,00 48,00	42,00 69,00	46,00 85,00	42,00 67,00	55,00 93,00	59,00 110,00	64,00 90,00	67,00 95,00	72,00 105,00	64,00 92,00	68,00 100,00	72,00 118,00
1022-14	 frei	Radverkehr und Mofas frei	420 x 420 600 x 600	39,00 59,00	53,00 86,00	63,00 107,00	50,00 83,00	67,00 117,00	76,00 138,00	70,00 89,00	76,00 98,00	82,00 114,00	75,00 109,00	81,00 121,00	92,00 143,00
1022-15	 frei	E-Bikes und Mofas frei	420 x 420 600 x 600												
1024-10	 frei	Personenkraftwagen frei	315 x 420 450 x 600 562 x 750	25,00 39,00 62,00	34,00 55,00 84,00	37,00 68,00 102,00	34,00 54,00 81,00	44,00 74,00 108,00	47,00 88,00 126,00	52,00 72,00 95,00	54,00 76,00 102,00	58,00 84,00 116,00	51,00 74,00 130,00	55,00 80,00 142,00	58,00 94,00 166,00
1024-11	 frei	Personenkraftwagen mit Anhänger frei	315 x 420 450 x 600 562 x 750	31,00 48,00 77,00	42,00 69,00 105,00	46,00 85,00 128,00	42,00 67,00 101,00	55,00 93,00 135,00	59,00 110,00 158,00	64,00 90,00 119,00	67,00 95,00 127,00	72,00 105,00 145,00	64,00 92,00 163,00	68,00 100,00 178,00	72,00 118,00 207,00
1024-12	 frei	Kraftfahrzeuge mit einer zuläs- sigen Gesamtmasse über 3,5 t, einschließlich ihrer Anhänger, und Zugmaschinen, ausgenommen Personenkraftwagen und Kraftomnibusse frei	315 x 420 450 x 600 562 x 750	25,00 39,00 62,00	34,00 55,00 84,00	37,00 68,00 102,00	34,00 54,00 81,00	44,00 74,00 108,00	47,00 88,00 126,00	52,00 72,00 95,00	54,00 76,00 102,00	58,00 84,00 116,00	51,00 74,00 130,00	55,00 80,00 142,00	58,00 94,00 166,00
1024-13	 frei	Lastkraftwagen mit Anhänger frei	315 x 420 450 x 600 562 x 750	31,00 48,00 77,00	42,00 69,00 105,00	46,00 85,00 128,00	42,00 67,00 101,00	55,00 93,00 135,00	59,00 110,00 158,00	64,00 90,00 119,00	67,00 95,00 127,00	72,00 105,00 145,00	64,00 92,00 163,00	68,00 100,00 178,00	72,00 118,00 207,00
1024-14	 frei	Kraftomnibusse frei	315 x 420 450 x 600 562 x 750												

















VERKEHRSZEICHEN

Nr.	Zeichen	Bedeutung	Maße in mm	Flachform 2 mm			Flachform 3 mm			Rundform			Alform			
				Folie RA1	Folie RA2	Folie RA3	Folie RA1	Folie RA2	Folie RA3	Folie RA1	Folie RA2	Folie RA3	Folie RA1	Folie RA2	Folie RA3	
1024-15		Schienenbahnen frei	315 x 420 450 x 600													
1024-16		Straßenbahnen frei	315 x 420 450 x 600	31,00 48,00	42,00 69,00	46,00 85,00	42,00 67,00	55,00 93,00	59,00 110,00	64,00 90,00	67,00 95,00	72,00 105,00	64,00 92,00	68,00 100,00	72,00 118,00	
1024-17		Kraftfahrzeuge und Züge, die nicht schneller als 25 km/h fahren können oder dürfen, frei	315 x 420 450 x 600													
1024-18		Gespannfuhrwerke frei	315 x 420 450 x 600													
1024-19		Wohnmobile mit einer zulässigen Gesamtmasse bis 7,5 t ausgenommen	420 x 420 600 x 600 750 x 750	39,00 59,00 95,00	53,00 86,00 130,00	63,00 107,00 164,00	50,00 83,00 127,00	67,00 117,00 169,00	76,00 138,00 203,00	70,00 89,00 131,00	76,00 98,00 144,00	82,00 114,00 168,00	75,00 109,00 195,00	81,00 121,00 213,00	92,00 143,00 258,00	
1024-20		Elektrisch betriebene Fahrzeuge frei	315 x 420 450 x 600 562 x 750	31,00 48,00 77,00	42,00 69,00 105,00	46,00 85,00 128,00	42,00 67,00 101,00	55,00 93,00 135,00	59,00 110,00 158,00	64,00 90,00 119,00	67,00 95,00 127,00	72,00 105,00 145,00	64,00 92,00 163,00	68,00 100,00 178,00	72,00 118,00 207,00	
1026-30		Taxi frei	315 x 420 450 x 600	25,00 39,00	34,00 55,00	37,00 68,00	34,00 54,00	44,00 74,00	47,00 88,00	52,00 72,00	54,00 76,00	58,00 84,00	51,00 74,00	55,00 80,00	58,00 94,00	
1026-31		Kraftomnibusse im Gelegenheitsverkehr frei	231 x 420 330 x 600	26,00 38,00	36,00 54,00	41,00 63,00	34,00 53,00	46,00 72,00	51,00 81,00	48,00 66,00	52,00 70,00	56,00 75,00	55,00 77,00	60,00 83,00	65,00 92,00	
1026-32		Linienverkehr frei	315 x 420 450 x 600 562 x 750													
1026-33		Einsatzfahrzeuge frei	315 x 420 450 x 600 562 x 750	25,00 39,00 62,00	34,00 55,00 84,00	37,00 68,00 102,00	34,00 54,00 81,00	44,00 74,00 108,00	47,00 88,00 126,00	52,00 72,00 95,00	54,00 76,00 102,00	58,00 84,00 116,00	51,00 74,00 130,00	55,00 80,00 142,00	58,00 94,00 166,00	
1026-34		Krankenfahrzeuge frei	315 x 420 450 x 600 562 x 750													
1026-35		Lieferverkehr frei	315 x 420 450 x 600 562 x 750													
1026-36		Landwirtschaftlicher Verkehr frei	315 x 420 450 x 600													
1026-37		Forstwirtschaftlicher Verkehr frei	315 x 420 450 x 600	25,00 39,00	34,00 55,00	37,00 68,00	34,00 54,00	44,00 74,00	47,00 88,00	52,00 72,00	54,00 76,00	58,00 84,00	51,00 74,00	55,00 80,00	58,00 94,00	
1026-38		Land- und forstwirtschaftlicher Verkehr frei	315 x 420 450 x 600													
1026-39		Betriebs- und Versorgungsdienst frei	231 x 420 330 x 600	21,00 30,00	29,00 43,00	33,00 50,00	27,00 42,00	37,00 58,00	41,00 65,00	38,00 53,00	42,00 56,00	45,00 60,00	44,00 61,00	48,00 66,00	52,00 74,00	

Nr.	Zeichen	Bedeutung	Maße in mm	Flachform 2 mm			Flachform 3 mm			Rundform			Alform		
				Folie RA1	Folie RA2	Folie RA3	Folie RA1	Folie RA2	Folie RA3	Folie RA1	Folie RA2	Folie RA3	Folie RA1	Folie RA2	Folie RA3
1026-60		Elektrofahrzeuge während des Ladevorgangs frei	420 x 420 600 x 600	39,00 59,00	53,00 86,00	63,00 107,00	50,00 83,00	67,00 117,00	76,00 138,00	70,00 89,00	76,00 98,00	82,00 114,00	75,00 109,00	81,00 121,00	92,00 143,00
1026-61		Elektrofahrzeuge frei	315 x 420 450 x 600	31,00 48,00	42,00 69,00	46,00 85,00	42,00 67,00	55,00 93,00	59,00 110,00	64,00 90,00	67,00 95,00	72,00 105,00	64,00 92,00	68,00 100,00	72,00 118,00
1026-62		Gütletransport frei	231 x 420 330 x 600	26,00 38,00	36,00 54,00	41,00 63,00	34,00 53,00	46,00 72,00	51,00 81,00	48,00 66,00	52,00 70,00	56,00 75,00	55,00 77,00	60,00 83,00	65,00 92,00
1026-63		E-Bikes frei	231 x 420 330 x 600												
1028-30		Baustellenfahrzeuge frei	315 x 420 450 x 600 562 x 750	25,00 39,00 62,00	34,00 55,00 84,00	37,00 68,00 102,00	34,00 54,00 81,00	44,00 74,00 108,00	47,00 88,00 126,00	52,00 72,00 95,00	54,00 76,00 102,00	58,00 84,00 116,00	51,00 74,00 130,00	55,00 80,00 142,00	58,00 94,00 166,00
1028-31		bis Baustelle frei	231 x 420 330 x 600	21,00 30,00	29,00 43,00	33,00 50,00	27,00 42,00	37,00 58,00	41,00 65,00	38,00 53,00	42,00 56,00	45,00 60,00	44,00 61,00	48,00 66,00	52,00 74,00
1028-32		Anlieger bis Baustelle frei	231 x 420 330 x 600												
1028-33		Zufahrt bis ... frei	315 x 420 450 x 600	25,00 39,00	34,00 55,00	37,00 68,00	34,00 54,00	44,00 74,00	47,00 88,00	52,00 72,00	54,00 76,00	58,00 84,00	51,00 74,00	55,00 80,00	58,00 94,00
1028-34		Fährbenutzer frei	315 x 420 450 x 600	31,00 48,00	42,00 69,00	46,00 85,00	42,00 67,00	55,00 93,00	59,00 110,00	64,00 90,00	67,00 95,00	72,00 105,00	64,00 92,00	68,00 100,00	72,00 118,00
1031-50		Freistellung vom Verkehrsverbot nach § 40 Abs. 1 des Bundes-Immissionsschutzgesetzes. Rote, gelbe und grüne Plakette frei	450 x 600 562 x 750												
1031-51		Freistellung vom Verkehrsverbot nach § 40 Abs. 1 des Bundes-Immissionsschutzgesetzes. Gelbe und grüne Plakette frei	450 x 600 562 x 750	48,00 77,00	69,00 105,00	85,00 128,00	67,00 101,00	93,00 135,00	110,00 158,00	90,00 119,00	95,00 127,00	105,00 145,00	92,00 163,00	100,00 178,00	118,00 207,00
1031-52		Freistellung vom Verkehrsverbot nach § 40 Abs. 1 des Bundes-Immissionsschutzgesetzes. Grüne Plakette frei	450 x 600 562 x 750												
1040-10		Wintersport erlaubt, zeitlich beschränkt	231 x 420 330 x 600	26,00 38,00	36,00 54,00	41,00 63,00	34,00 53,00	46,00 72,00	51,00 81,00	48,00 66,00	52,00 70,00	56,00 75,00	55,00 77,00	60,00 83,00	65,00 92,00
1040-30		Zeitliche Beschränkung	231 x 420 330 x 600 412 x 750	21,00 30,00 48,00	29,00 43,00 65,00	33,00 50,00 78,00	27,00 42,00 62,00	37,00 58,00 83,00	41,00 65,00 96,00	38,00 53,00 80,00	42,00 56,00 84,00	45,00 60,00 95,00	44,00 61,00 105,00	48,00 66,00 115,00	52,00 74,00 132,00
1040-31		Zeitliche Beschränkung	231 x 420 330 x 600 412 x 750												
1040-32		Parkscheibe ... Stunden	231 x 420 330 x 600	21,00 30,00	29,00 43,00	33,00 50,00	27,00 42,00	37,00 58,00	41,00 65,00	38,00 53,00	42,00 56,00	45,00 60,00	44,00 61,00	48,00 66,00	52,00 74,00







VERKEHRSSZEICHEN

Nr.	Zeichen	Bedeutung	Maße in mm	Flachform 2 mm			Flachform 3 mm			Rundform			Alform		
				Folie RA1	Folie RA2	Folie RA3	Folie RA1	Folie RA2	Folie RA3	Folie RA1	Folie RA2	Folie RA3	Folie RA1	Folie RA2	Folie RA3
1040-33		Parken mit Parkscheibe in gekennzeichneten Flächen ... Stunden	231 x 420 330 x 600	21,00 30,00	29,00 43,00	33,00 50,00	27,00 42,00	37,00 58,00	41,00 65,00	38,00 53,00	42,00 56,00	45,00 60,00	44,00 61,00	48,00 66,00	52,00 74,00
1040-34		Ab Zeitpunkt	231 x 420 330 x 600	26,00 38,00	36,00 54,00	41,00 63,00	34,00 53,00	46,00 72,00	51,00 81,00	48,00 66,00	52,00 70,00	56,00 75,00	55,00 77,00	60,00 83,00	65,00 92,00
1040-35		Lärmschutz (mit Zeitangabe)	231 x 420 330 x 600 412 x 750	26,00 38,00 59,00	36,00 54,00 81,00	41,00 63,00 97,00	34,00 53,00 77,00	46,00 72,00 103,00	51,00 81,00 119,00	48,00 66,00 100,00	52,00 70,00 105,00	56,00 75,00 118,00	55,00 77,00 132,00	60,00 83,00 143,00	65,00 92,00 165,00
1040-36		Schulweg i.V.m. zeitlicher Begrenzung (zu Z 101 oder 274)	231 x 420 330 x 600	26,00 38,00	36,00 54,00	41,00 63,00	34,00 53,00	46,00 72,00	51,00 81,00	48,00 66,00	52,00 70,00	56,00 75,00	55,00 77,00	60,00 83,00	65,00 92,00
1042-30		Zeitliche Beschränkung	231 x 420 330 x 600	21,00 30,00	29,00 43,00	33,00 50,00	27,00 42,00	37,00 58,00	41,00 65,00	38,00 53,00	42,00 56,00	45,00 60,00	44,00 61,00	48,00 66,00	52,00 74,00
1042-31		Zeitliche Beschränkung	231 x 420 330 x 600												
1042-32		Zeitliche Beschränkung	315 x 420 450 x 600	31,00 48,00	42,00 69,00	46,00 85,00	42,00 67,00	55,00 93,00	59,00 110,00	64,00 90,00	67,00 95,00	72,00 105,00	64,00 92,00	68,00 100,00	72,00 118,00
1042-33		Zeitliche Beschränkung	231 x 420 330 x 600	21,00 30,00	29,00 43,00	33,00 50,00	27,00 42,00	37,00 58,00	41,00 65,00	38,00 53,00	42,00 56,00	45,00 60,00	44,00 61,00	48,00 66,00	52,00 74,00
1042-34		Zeitliche Beschränkung	231 x 420 330 x 600	26,00 38,00	36,00 54,00	41,00 63,00	34,00 53,00	46,00 72,00	51,00 81,00	48,00 66,00	52,00 70,00	56,00 75,00	55,00 77,00	60,00 83,00	65,00 92,00
1042-35		Zeitliche Beschränkung	315 x 420 450 x 600												
1042-36		Schulbus (tageszeitliche Benutzung)	315 x 420 450 x 600	31,00 48,00	42,00 69,00	46,00 85,00	42,00 67,00	55,00 93,00	59,00 110,00	64,00 90,00	67,00 95,00	72,00 105,00	64,00 92,00	68,00 100,00	72,00 118,00
1042-37		Parken Samstag und Sonntag erlaubt	315 x 420 450 x 600												
1042-38		Werktags außer samstags	231 x 420 330 x 600	26,00 38,00	36,00 54,00	41,00 63,00	34,00 53,00	46,00 72,00	51,00 81,00	48,00 66,00	52,00 70,00	56,00 75,00	55,00 77,00	60,00 83,00	65,00 92,00
1042-50		Straßenreinigung (mit Zeit- und Datumsangabe)	420 x 420 600 x 600	39,00 59,00	53,00 86,00	63,00 107,00	50,00 83,00	67,00 117,00	76,00 138,00	70,00 89,00	76,00 98,00	82,00 114,00	75,00 109,00	81,00 121,00	92,00 143,00
1042-51		Sa und So	231 x 420 330 x 600	26,00 38,00	36,00 54,00	41,00 63,00	34,00 53,00	46,00 72,00	51,00 81,00	48,00 66,00	52,00 70,00	56,00 75,00	55,00 77,00	60,00 83,00	65,00 92,00
1042-52		Sa, So und an Feiertagen	315 x 420 450 x 600	31,00 48,00	42,00 69,00	46,00 85,00	42,00 67,00	55,00 93,00	59,00 110,00	64,00 90,00	67,00 95,00	72,00 105,00	64,00 92,00	68,00 100,00	72,00 118,00



























Nr.	Zeichen	Bedeutung	Maße in mm	Flachform 2 mm			Flachform 3 mm			Rundform			Alform		
				Folie RA1	Folie RA2	Folie RA3	Folie RA1	Folie RA2	Folie RA3	Folie RA1	Folie RA2	Folie RA3	Folie RA1	Folie RA2	Folie RA3
1042-53		Schulweg i.V.m. zeitlicher Begrenzung an Werktagen (zu Z 101 oder 274)	315 x 420 450 x 600	31,00 48,00	42,00 69,00	46,00 85,00	42,00 67,00	55,00 93,00	59,00 110,00	64,00 90,00	67,00 95,00	72,00 105,00	64,00 92,00	68,00 100,00	72,00 118,00
1044-10		Nur Schwerbehinderte mit außergewöhnlicher Gehbehinderung und Blinde	231 x 420 330 x 600	21,00 30,00	29,00 43,00	33,00 50,00	27,00 42,00	37,00 58,00	41,00 65,00	38,00 53,00	42,00 56,00	45,00 60,00	44,00 61,00	48,00 66,00	52,00 74,00
1044-11		Nur Schwerbehinderte mit Parkausweis Nr. ...	231 x 420 330 x 600												
1044-12		Nur Schwerbehinderte mit außergewöhnlicher Gehbehinderung und Blinde mit Anzahl der Parkstände	315 x 420 450 x 600	31,00 48,00	42,00 69,00	46,00 85,00	42,00 67,00	55,00 93,00	59,00 110,00	64,00 90,00	67,00 95,00	72,00 105,00	64,00 92,00	68,00 100,00	72,00 118,00
1044-30		Nur Bewohner mit Parkausweis Nr. ...	231 x 420 330 x 600	21,00 30,00	29,00 43,00	33,00 50,00	27,00 42,00	37,00 58,00	41,00 65,00	38,00 53,00	42,00 56,00	45,00 60,00	44,00 61,00	48,00 66,00	52,00 74,00
1048-14		Nur Sattelkraftfahrzeuge	231 x 420 330 x 600 412 x 750	26,00 38,00 59,00	36,00 54,00 81,00	41,00 63,00 97,00	34,00 53,00 77,00	46,00 72,00 103,00	51,00 81,00 119,00	48,00 66,00 100,00	52,00 70,00 105,00	56,00 75,00 118,00	55,00 77,00 132,00	60,00 83,00 143,00	65,00 92,00 165,00
1048-15		Nur Sattelkraftfahrzeuge und Lastkraftwagen mit Anhänger	315 x 420 450 x 600 562 x 750	31,00 48,00 77,00	42,00 69,00 105,00	46,00 85,00 128,00	42,00 67,00 101,00	55,00 93,00 135,00	59,00 110,00 158,00	64,00 90,00 119,00	67,00 95,00 127,00	72,00 105,00 145,00	64,00 92,00 163,00	68,00 100,00 178,00	72,00 118,00 207,00
1048-18		Nur Schienenbahnen	315 x 420 450 x 600	25,00 39,00	34,00 55,00	37,00 68,00	34,00 54,00	44,00 74,00	47,00 88,00	52,00 72,00	54,00 76,00	58,00 84,00	51,00 74,00	55,00 80,00	58,00 94,00
1048-20		Nur Pkw mit Anhänger und Kraftfahrzeuge mit einer zulässigen Gesamtmasse über 3,5 t, einschl. ihrer Anhänger, und Zugmaschinen ausgenommen Pkw und Kraftomnibusse	315 x 420 450 x 600 562 x 750	31,00 48,00 77,00	42,00 69,00 105,00	46,00 85,00 128,00	42,00 67,00 101,00	55,00 93,00 135,00	59,00 110,00 158,00	64,00 90,00 119,00	67,00 95,00 127,00	72,00 105,00 145,00	64,00 92,00 163,00	68,00 100,00 178,00	72,00 118,00 207,00
1049-11		Kraftfahrzeuge und Züge, die nicht schneller als 25 km/h fahren können oder dürfen, dürfen überholt werden	315 x 420 450 x 600	31,00 48,00	42,00 69,00	46,00 85,00	42,00 67,00	55,00 93,00	59,00 110,00	64,00 90,00	67,00 95,00	72,00 105,00	64,00 92,00	68,00 100,00	72,00 118,00
1049-12		Nur militärische Kettenfahrzeuge	231 x 420 330 x 600	26,00 38,00	36,00 54,00	41,00 63,00	34,00 53,00	46,00 72,00	51,00 81,00	48,00 66,00	52,00 70,00	56,00 75,00	55,00 77,00	60,00 83,00	65,00 92,00
1049-13		Nur Lkw (Zeichen 1010-51), Kraftomnibus (Zeichen 1010-57) und Pkw mit Anhänger (Zeichen 1010-59)	420 x 420 600 x 600 750 x 750	31,00 48,00 76,00	43,00 69,00 104,00	51,00 86,00 131,00	40,00 67,00 102,00	53,00 93,00 135,00	61,00 110,00 163,00	56,00 71,00 105,00	61,00 78,00 116,00	66,00 91,00 135,00	60,00 87,00 156,00	65,00 97,00 171,00	73,00 114,00 207,00
1050-30		Taxi	231 x 420 330 x 600	21,00 30,00	29,00 43,00	33,00 50,00	27,00 42,00	37,00 58,00	41,00 65,00	38,00 53,00	42,00 56,00	45,00 60,00	44,00 61,00	48,00 66,00	52,00 74,00
1050-31		... Taxen	231 x 420 330 x 600	26,00 38,00	36,00 54,00	41,00 63,00	34,00 53,00	46,00 72,00	51,00 81,00	48,00 66,00	52,00 70,00	56,00 75,00	55,00 77,00	60,00 83,00	65,00 92,00
1050-32		Elektrofahrzeuge während des Ladevorgangs	315 x 420 450 x 600	31,00 48,00	42,00 69,00	46,00 85,00	42,00 67,00	55,00 93,00	59,00 110,00	64,00 90,00	67,00 95,00	72,00 105,00	64,00 92,00	68,00 100,00	72,00 118,00
1050-33		Elektrofahrzeuge	231 x 420 330 x 600	26,00 38,00	36,00 54,00	41,00 63,00	34,00 53,00	46,00 72,00	51,00 81,00	48,00 66,00	52,00 70,00	56,00 75,00	55,00 77,00	60,00 83,00	65,00 92,00

VERKEHRSZEICHEN

Nr.	Zeichen	Bedeutung	Maße in mm	Flachform 2 mm			Flachform 3 mm			Rundform			Alform		
				Folie RA1	Folie RA2	Folie RA3	Folie RA1	Folie RA2	Folie RA3	Folie RA1	Folie RA2	Folie RA3	Folie RA1	Folie RA2	Folie RA3
1052-30		Nur kennzeichnungs- pflichtige Kraftfahrzeuge mit gefährlichen Gütern	315 x 420 450 x 600 562 x 750	31,00 48,00 77,00	42,00 69,00 105,00	46,00 85,00 128,00	42,00 67,00 101,00	55,00 93,00 135,00	59,00 110,00 158,00	64,00 90,00 119,00	67,00 95,00 127,00	72,00 105,00 145,00	64,00 92,00 163,00	68,00 100,00 178,00	72,00 118,00 207,00
1052-31		Nur Fahrzeuge mit wassergefährdender Ladung	315 x 420 450 x 600 562 x 750												
1053-30		Parken in gekenn- zeichneten Flächen erlaubt	231 x 420 330 x 600												
1053-31		Mit Parkschein	231 x 420 330 x 600	21,00 30,00	29,00 43,00	33,00 50,00	27,00 42,00	37,00 58,00	41,00 65,00	38,00 53,00	42,00 56,00	45,00 60,00	44,00 61,00	48,00 66,00	52,00 74,00
1053-32		Gebührenpflichtig	231 x 420 330 x 600												
1053-33		Massenangabe – 7,5 t	231 x 420 330 x 600 412 x 750	21,00 30,00 48,00	29,00 43,00 65,00	33,00 50,00 78,00	27,00 42,00 62,00	37,00 58,00 83,00	41,00 65,00 96,00	38,00 53,00 80,00	42,00 56,00 84,00	45,00 60,00 95,00	44,00 61,00 105,00	48,00 66,00 115,00	52,00 74,00 132,00
1053-34		Auf dem Seitenstreifen	231 x 420 330 x 600 412 x 750												
1053-35		Bei Nässe	420 x 420 600 x 600 750 x 750	31,00 48,00 76,00	43,00 69,00 104,00	51,00 86,00 131,00	40,00 67,00 102,00	53,00 93,00 135,00	61,00 110,00 163,00	56,00 71,00 105,00	61,00 78,00 116,00	66,00 91,00 135,00	60,00 87,00 156,00	65,00 97,00 171,00	73,00 114,00 207,00
1053-36		Durchgangs- verkehr	231 x 420 330 x 600 412 x 750	26,00 38,00 59,00	36,00 54,00 81,00	41,00 63,00 97,00	34,00 53,00 77,00	46,00 72,00 103,00	51,00 81,00 119,00	48,00 66,00 100,00	52,00 70,00 105,00	56,00 75,00 118,00	55,00 77,00 132,00	60,00 83,00 143,00	65,00 92,00 165,00
1053-37		Massenangabe – 12 t	231 x 420 330 x 600 412 x 750												
1053-38		Querparken als Sinnbild	420 x 420 600 x 600												
1053-39		Schrägparken als Sinnbild	420 x 420 600 x 600	39,00 59,00	53,00 86,00	63,00 107,00	50,00 83,00	67,00 117,00	76,00 138,00	70,00 89,00	76,00 98,00	82,00 114,00	75,00 109,00	81,00 121,00	92,00 143,00
1053-52		nur innerhalb gekenn- zeichneter Parkflächen	420 x 420 600 x 600												
1053-53		Parken mit Parkschein in gekenn- zeichneten Flächen	420 x 420 600 x 600												
1060-31		Haltverbot auch auf dem Seitenstreifen	231 x 420 330 x 600 412 x 750	21,00 30,00 48,00	29,00 43,00 65,00	33,00 50,00 78,00	27,00 42,00 62,00	37,00 58,00 83,00	41,00 65,00 96,00	38,00 53,00 80,00	42,00 56,00 84,00	45,00 60,00 95,00	44,00 61,00 105,00	48,00 66,00 115,00	52,00 74,00 132,00
1060-32		auch Kraftomni- busse und Pkw mit Anhängern	420 x 420 600 x 600 750 x 750	39,00 59,00 95,00	53,00 86,00 130,00	63,00 107,00 164,00	50,00 83,00 127,00	67,00 117,00 169,00	76,00 138,00 203,00	70,00 89,00 131,00	76,00 98,00 144,00	82,00 114,00 168,00	75,00 109,00 195,00	81,00 121,00 213,00	92,00 143,00 258,00



















Nr.	Zeichen	Bedeutung	Maße in mm	Flachform 2 mm			Flachform 3 mm			Rundform			Alform		
				Folie RA1	Folie RA2	Folie RA3	Folie RA1	Folie RA2	Folie RA3	Folie RA1	Folie RA2	Folie RA3	Folie RA1	Folie RA2	Folie RA3
1060-33		Massenangabe – 2,8 t	231 x 420 330 x 600 412 x 750	26,00 38,00 59,00	36,00 54,00 81,00	41,00 63,00 97,00	34,00 53,00 77,00	46,00 72,00 103,00	51,00 81,00 119,00	48,00 66,00 100,00	52,00 70,00 105,00	56,00 75,00 118,00	55,00 77,00 132,00	60,00 83,00 143,00	65,00 92,00 165,00
Br. 1		Militärische Tragfähigkeitszeichen an Brücken (Nato-Brückenschild)	Ø 500 lackiert	24,00	-	-	-	-	-	-	-	-	40,00	-	-
Br. 2		Militärische Tragfähigkeitszeichen an Brücken (Nato-Brückenschild)	Ø 400 lackiert	19,00	-	-	-	-	-	-	-	-	34,00	-	-
Br. 3		Militärische Tragfähigkeitszeichen an Brücken (Nato-Brückenschild)	Ø 500 lackiert												
Br. 4		Militärische Tragfähigkeitszeichen an Brücken (Nato-Brückenschild)	Ø 500 lackiert	24,00	-	-	-	-	-	-	-	-	40,00	-	-
Br. 5		Militärische Tragfähigkeitszeichen an Brücken (Nato-Brückenschild)	Ø 500 lackiert												

VERKEHRSZEICHEN

Nr.	Zeichen	Bedeutung	Maße in mm	Flachform 2 mm			Flachform 3 mm			Rundform			Alform		
				Folie RA1	Folie RA2	Folie RA3	Folie RA1	Folie RA2	Folie RA3	Folie RA1	Folie RA2	Folie RA3	Folie RA1	Folie RA2	Folie RA3
2001		2002 	231 x 420 330 x 600 412 x 750	21,00	29,00	33,00	27,00	37,00	41,00	38,00	42,00	45,00	44,00	48,00	52,00
				30,00	43,00	50,00	42,00	58,00	65,00	53,00	56,00	60,00	61,00	66,00	74,00
2003		2004 	231 x 420 330 x 600 412 x 750	21,00	29,00	33,00	27,00	37,00	41,00	38,00	42,00	45,00	44,00	48,00	52,00
				30,00	43,00	50,00	42,00	58,00	65,00	53,00	56,00	60,00	61,00	66,00	74,00
2005			315 x 420 450 x 600 562 x 750	25,00	34,00	37,00	34,00	44,00	47,00	52,00	54,00	58,00	51,00	55,00	58,00
				39,00	55,00	68,00	54,00	74,00	88,00	72,00	76,00	84,00	74,00	80,00	94,00
2008			231 x 420 330 x 600 412 x 750	21,00	29,00	33,00	27,00	37,00	41,00	38,00	42,00	45,00	44,00	48,00	52,00
				30,00	43,00	50,00	42,00	58,00	65,00	53,00	56,00	60,00	61,00	66,00	74,00
2009		2010 	231 x 420 330 x 600	21,00	29,00	33,00	27,00	37,00	41,00	38,00	42,00	45,00	44,00	48,00	52,00
				30,00	43,00	50,00	42,00	58,00	65,00	53,00	56,00	60,00	61,00	66,00	74,00
2011		2012 	231 x 420 330 x 600 412 x 750												
2014			231 x 420 330 x 600 412 x 750												
2101		2102 	231 x 420 330 x 600 412 x 750												
2111		2112 	231 x 420 330 x 600 412 x 750	21,00	29,00	33,00	27,00	37,00	41,00	38,00	42,00	45,00	44,00	48,00	52,00
				30,00	43,00	50,00	42,00	58,00	65,00	53,00	56,00	60,00	61,00	66,00	74,00
2113		2114 	231 x 420 330 x 600 412 x 750	21,00	29,00	33,00	27,00	37,00	41,00	38,00	42,00	45,00	44,00	48,00	52,00
				30,00	43,00	50,00	42,00	58,00	65,00	53,00	56,00	60,00	61,00	66,00	74,00
2121		2122 	231 x 420 330 x 600 412 x 750												
2123			231 x 420 330 x 600 412 x 750												
2132		2133 	315 x 420 450 x 600 562 x 750	25,00	34,00	37,00	34,00	44,00	47,00	52,00	54,00	58,00	51,00	55,00	58,00
				39,00	55,00	68,00	54,00	74,00	88,00	72,00	76,00	84,00	74,00	80,00	94,00
2134		2139 	231 x 420 330 x 600 412 x 750	21,00	29,00	33,00	27,00	37,00	41,00	38,00	42,00	45,00	44,00	48,00	52,00
				30,00	43,00	50,00	42,00	58,00	65,00	53,00	56,00	60,00	61,00	66,00	74,00
2140			231 x 420 330 x 600 412 x 750												
2161			315 x 420 450 x 600 562 x 750	25,00	34,00	37,00	34,00	44,00	47,00	52,00	54,00	58,00	51,00	55,00	58,00
				39,00	55,00	68,00	54,00	74,00	88,00	72,00	76,00	84,00	74,00	80,00	94,00
				62,00	84,00	102,00	81,00	108,00	126,00	95,00	102,00	116,00	130,00	142,00	166,00

Nr.	Zeichen	Bedeutung	Maße in mm	Flachform 2 mm			Flachform 3 mm			Rundform			Alform			
				Folie RA1	Folie RA2	Folie RA3	Folie RA1	Folie RA2	Folie RA3	Folie RA1	Folie RA2	Folie RA3	Folie RA1	Folie RA2	Folie RA3	
2201		2202		315 x 420 450 x 600 562 x 750	25,00 39,00 62,00	34,00 55,00 84,00	37,00 68,00 102,00	34,00 54,00 81,00	44,00 74,00 108,00	47,00 88,00 126,00	52,00 72,00 95,00	54,00 76,00 102,00	58,00 84,00 116,00	51,00 74,00 130,00	55,00 80,00 142,00	58,00 94,00 166,00
2211		2212		315 x 420 450 x 600 562 x 750												
2303		2304		231 x 420 330 x 600 412 x 750												
2401		2402		231 x 420 330 x 600 412 x 750	21,00 30,00 48,00	29,00 43,00 65,00	33,00 50,00 78,00	27,00 42,00 62,00	37,00 58,00 83,00	41,00 65,00 96,00	38,00 53,00 80,00	42,00 56,00 84,00	45,00 60,00 95,00	44,00 61,00 105,00	48,00 66,00 115,00	52,00 74,00 132,00
2403				231 x 420 330 x 600 412 x 750												
2411				231 x 420 330 x 600	26,00 38,00	36,00 54,00	41,00 63,00	34,00 53,00	46,00 72,00	51,00 81,00	48,00 66,00	52,00 70,00	56,00 75,00	55,00 77,00	60,00 83,00	65,00 92,00
2421				231 x 420 330 x 600 412 x 750												
2422		2423		231 x 420 330 x 600 412 x 750	21,00 30,00 48,00	29,00 43,00 65,00	33,00 50,00 78,00	27,00 42,00 62,00	37,00 58,00 83,00	41,00 65,00 96,00	38,00 53,00 80,00	42,00 56,00 84,00	45,00 60,00 95,00	44,00 61,00 105,00	48,00 66,00 115,00	52,00 74,00 132,00
2425		2427		231 x 420 330 x 600 412 x 750												
2428		2429		231 x 420 330 x 600 412 x 750												
2431				315 x 420 450 x 600 562 x 750	25,00 39,00 62,00	34,00 55,00 84,00	37,00 68,00 102,00	34,00 54,00 81,00	44,00 74,00 108,00	47,00 88,00 126,00	52,00 72,00 95,00	54,00 76,00 102,00	58,00 84,00 116,00	51,00 74,00 130,00	55,00 80,00 142,00	58,00 94,00 166,00
2432		2433		315 x 420 450 x 600 562 x 750	31,00 48,00 77,00	42,00 69,00 105,00	46,00 85,00 128,00	42,00 67,00 101,00	55,00 93,00 135,00	59,00 110,00 158,00	64,00 90,00 119,00	67,00 95,00 127,00	72,00 105,00 145,00	64,00 92,00 163,00	68,00 100,00 178,00	72,00 118,00 207,00
2441				600 x 600	48,00	69,00	86,00	67,00	93,00	110,00	71,00	78,00	91,00	87,00	97,00	114,00
2449				333 x 1000	50,00	67,00	81,00	66,00	86,00	100,00	-	-	-	119,00	127,00	146,00
2501		2502		231 x 420 330 x 600 412 x 750	21,00 30,00 48,00	29,00 43,00 65,00	33,00 50,00 78,00	27,00 42,00 62,00	37,00 58,00 83,00	41,00 65,00 96,00	38,00 53,00 80,00	42,00 56,00 84,00	45,00 60,00 95,00	44,00 61,00 105,00	48,00 66,00 115,00	52,00 74,00 132,00
2503		2531		231 x 420 330 x 600 412 x 750												

VERKEHRSZEICHEN

Nr.	Zeichen	Bedeutung	Maße in mm	Flachform 2 mm			Flachform 3 mm			Rundform			Alform		
				Folie RA1	Folie RA2	Folie RA3	Folie RA1	Folie RA2	Folie RA3	Folie RA1	Folie RA2	Folie RA3	Folie RA1	Folie RA2	Folie RA3
2532		2535 	231 x 420 330 x 600 412 x 750												
2802			231 x 420 330 x 600 412 x 750	21,00 30,00 48,00	29,00 43,00 65,00	33,00 50,00 78,00	27,00 42,00 62,00	37,00 58,00 83,00	41,00 65,00 96,00	38,00 53,00 80,00	42,00 56,00 84,00	45,00 60,00 95,00	44,00 61,00 105,00	48,00 66,00 115,00	52,00 74,00 132,00
2803		2804 	231 x 420 330 x 600 412 x 750												
2811			420 x 315 600 x 450	31,00 48,00	42,00 69,00	46,00 85,00	42,00 67,00	55,00 93,00	59,00 110,00	64,00 90,00	67,00 95,00	72,00 105,00	64,00 92,00	68,00 100,00	72,00 118,00
2821		2822 	231 x 420 330 x 600	26,00 38,00	36,00 54,00	41,00 63,00	34,00 53,00	46,00 72,00	51,00 81,00	48,00 66,00	52,00 70,00	56,00 75,00	55,00 77,00	60,00 83,00	65,00 92,00
2823		2824 	231 x 420 330 x 600												
2825			315 x 420 450 x 600	31,00 48,00	42,00 69,00	46,00 85,00	42,00 67,00	55,00 93,00	59,00 110,00	64,00 90,00	67,00 95,00	72,00 105,00	64,00 92,00	68,00 100,00	72,00 118,00
2831		2832 	231 x 420 330 x 600	26,00 38,00	36,00 54,00	41,00 63,00	34,00 53,00	46,00 72,00	51,00 81,00	48,00 66,00	52,00 70,00	56,00 75,00	55,00 77,00	60,00 83,00	65,00 92,00
2841			231 x 420 330 x 600												
2842		2843 	315 x 420 450 x 600	31,00 48,00	42,00 69,00	46,00 85,00	42,00 67,00	55,00 93,00	59,00 110,00	64,00 90,00	67,00 95,00	72,00 105,00	64,00 92,00	68,00 100,00	72,00 118,00
2844			420 x 420 600 x 600	39,00 59,00	53,00 86,00	63,00 107,00	50,00 83,00	67,00 117,00	76,00 138,00	70,00 89,00	76,00 98,00	82,00 114,00	75,00 109,00	81,00 121,00	92,00 143,00
2851			231 x 420 330 x 600	26,00 38,00	36,00 54,00	41,00 63,00	34,00 53,00	46,00 72,00	51,00 81,00	48,00 66,00	52,00 70,00	56,00 75,00	55,00 77,00	60,00 83,00	65,00 92,00
2852			315 x 420 450 x 600	31,00 48,00	42,00 69,00	46,00 85,00	42,00 67,00	55,00 93,00	59,00 110,00	64,00 90,00	67,00 95,00	72,00 105,00	64,00 92,00	68,00 100,00	72,00 118,00

VOR- UND TABELLENWEGWEISER (AUSFÜHRUNG NACH RWB UND RWBA)



Zeichen 434
Tabellewegweiser



Zeichen 435
Wegweiser innerorts auf Bundesstraßen



Zeichen 436
Wegweiser innerorts auf sonstigen Straßen



Zeichen 438
Vorwegweiser



Zeichen 439
Gegliedertes Vorwegweiser

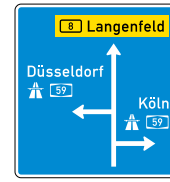

Zeichen 440
Vorwegweiser zur Autobahn

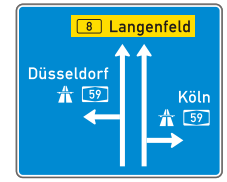

Zeichen 441
Gegliedertes Vorwegweiser zur Autobahn



Zeichen 448
Ankündigungstafel auf Autobahnen



Zeichen 448.1
Hinweistafel auf Autohöfe an Autobahnen

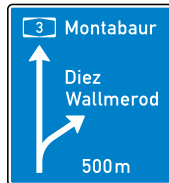

Zeichen 449
Vorwegweiser auf Autobahnen



Zeichen 453
Entfernungstafel auf Autobahnen



Alform II Profil



Alform III Profil

Ausführungen	Folie RA 1	Folie RA 2	Folie RA 3	Folie RA 3 brilliant	Aufpreis Anti-Graffiti-Schutzfilm Antitau pro m ²
	pro m ²	pro m ²	pro m ²	pro m ²	
Flachform, 2 mm	160,00	190,00	238,00	264,00	90,00
Flachform, 3 mm	200,00	233,00	282,00	310,00	90,00
Alform I	242,00	277,00	328,00	361,00	90,00
Alform II	295,00	314,00	369,00	406,00	90,00
Alform III	302,00	346,00	405,00	445,00	90,00
abgekantet	295,00	314,00	369,00	406,00	90,00
Abdecktafeln, 2 mm	160,00	190,00	238,00	264,00	90,00
Abdecktafeln, 3 mm	200,00	233,00	282,00	310,00	90,00
Die Schildgröße erfordert ein unterschiedliches Randprofil:			Schildgröße in m ²	Profil	
			0 - 1,1	Alform I	
			> 1,1 - 6,0	Alform II	
			> 6,0	Alform III	
	pro Stück	pro Stück	pro Stück	pro Stück	pro Stück
Abdecktafeln, 2 mm (<= 0,2 m ²)	30,00	36,00	47,00	52,00	17,00
Abdecktafeln, 3 mm (<= 0,2 m ²)	35,00	40,00	51,00	56,00	17,00



Baustellen-
informationsschild
für Bundesstraßen
2700 x 2000



Baustellen-
informationsschild für EU-För-
dermaßnahmen
2000 x 2000









Baustellen-
informationsschild
für Autobahnen
4000 x 3000

Maße in mm	Flachform 3 mm		Alform II		Alform III	
	Folie RA2	Folie RA3	Folie RA2	Folie RA3	Folie RA2	Folie RA3
2000 x 2000	932,00	1128,00	1256,00	1476,00	-	-
	.192 00 903PK	.192 00 9033K	.192 00 906PK	.192 00 9063K		
2700 x 2000	1259,00	1523,00	1696,00	1993,00	-	-
	.192 00 883PK	.192 00 8833K	.192 00 886PK	.192 00 8863K		
4000 x 3000	-	-	-	-	4152,00	4860,00
					.192 00 896PK	.192 00 8963K

Hinweisschilder für den Brandschutz nach DIN 4066: 1997-07, aus Aluminium

Standardschilder

Abbildung						
Art.-Nr.	HWSB010 XXXXXX	HWSB020 XXXXXX	HWSB030 XXXXXX	HWSB040 XXXXXX	HWSB050 XXXXXX	HWSB060 XXXXXX

Schildgröße in mm	Flachform 2 mm			Flachform 3 mm		
	RA 1	RA 2	RA 3	RA 1	RA 2	RA 3
74 x 210	21,10 HWSB... 072121	21,70 HWSB... 07212P	22,30 HWSB... 072123	-	-	-
105 x 297	24,80 HWSB... 102921	26,00 HWSB... 10292P	27,20 HWSB... 102923	-	-	-
148 x 420	31,90 HWSB... 144221	34,30 HWSB... 14422P	36,70 HWSB... 144223	-	-	-
210 x 594	46,40 HWSB... 215921	51,20 HWSB... 21592P	56,00 HWSB... 215923	51,20 HWSB... 215931	56,00 HWSB... 21593P	60,80 HWSB... 215933

Sonderschilder nach Kundenwunsch

Abbildung		
Art.-Nr.	HWSB210 XXXXXX	HWSB220 XXXXXX

Schildgröße in mm	Flachform 2 mm			Flachform 3 mm		
	RA 1	RA 2	RA 3	RA 1	RA 2	RA 3
74 x 210	28,10 HWSB... 072121	28,70 HWSB... 07212P	29,30 HWSB... 072123	-	-	-
105 x 297	31,80 HWSB... 102921	33,00 HWSB... 10292P	34,20 HWSB... 102923	-	-	-
148 x 420	38,90 HWSB... 144221	41,30 HWSB... 14422P	43,70 HWSB... 144223	-	-	-
210 x 594	53,40 HWSB... 215921	58,20 HWSB... 21592P	53,00 HWSB... 215923	58,20 HWSB... 215931	63,00 HWSB... 21593P	67,80 HWSB... 215933

Kunststoffschilder

			1 mm	2 mm	
2161		200 x 300	5,30	6,80	Der Schriftzug „Baustellenfahrzeug“ vom Bild 2181 01 ist außermittig angeordnet. Damit hat man die Möglichkeit, zusätzlich zum Beispiel ein Firmenlogo aufzukleben. Sondertexte (z.B. Digitalisierung von Logos) werden nach Aufwand berechnet.
2181 01		100 x 490 mit Saugfüßen	-	12,40	
2181 10		100 x 490 mit Saugfüßen	-	12,40	
2181 30		100 x 490 mit Saugfüßen	-	12,40	

MIT SICHERHEIT SAUBER

ANTI-GRAFFITI-SCHUTZFILM

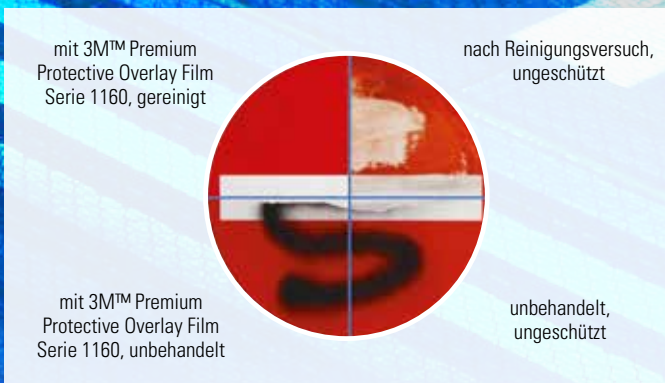

Aufpreise für Anti-Graffiti-Schutzfilm			
Form	Größe in mm	Art.-Nr.	Preis
Dreiecke	SL 630	T4- 5S	16,00
	SL 900	T4- 6S	32,00
	SL 1260	T4- 8S	62,00
Ronden	Ø 420	T4- 4D	16,00
	Ø 600	T4- 6D	33,00
	Ø 750	T4- 7D	51,00
Pfeilwegweiser	250 x 1000	T4- .W	23,00
	333 x 1250	T4- 3W	38,00
	350 x 1400	T4- 4W	45,00
Achtecke	900 x 900	T4- 9A	73,00
	1050 x 1050	T4- 0A	100,00
Quadrate	420 x 420	T4- 63	16,00
	500 x 500	T4- 08	23,00
	600 x 600	T4- 25	33,00
	750 x 750	T4- 13	51,00
	840 x 840	T4- 16	64,00
Rechtecke	231 x 420	T4- 61	9,00
	330 x 600	T4- 71	18,00
	412 x 750	T4- 81	28,00
	315 x 420	T4- 62	12,00
	450 x 600	T4- 72	25,00
	562 x 750	T4- 82	38,00
	630 x 420	T4- 64	24,00
	900 x 600	T4- 74	49,00
	1260 x 840	T4- 94	96,00
	250 x 1000	T4- 14	23,00
	300 x 800	T4- 30	22,00
	300 x 1000	T4- 15	27,00
	500 x 1000	T4- 10	45,00
	500 x 1500	T4- 57	68,00
	650 x 1000	T4- 11	59,00
	750 x 500	T4- 09	34,00
	Sondergröße	T4-999	90,00/m2

Die Lösung: 3M™ Premium Protective Overlay Film Serie 1160 in Verbindung mit 3M™ Graffiti-Farbentferner. Die Anwendung ist einfach:

Das Schild muss dazu mit 3M™ Premium Protective Overlay Film Serie 1160 ausgestattet sein. Die hoch transparente Folie, zusammen mit dem Farbentferner ermöglicht eine einfache und rückstandsfreie Entfernung von Stickern und Graffiti. Der 3M™ Graffiti-Farbentferner wird auf das verunreinigte VZ aufgetragen. Nach einer Einwirkzeit von 1-5 min können Sticker und Graffiti mit einem feuchten Tuch abgewischt werden.

Der 3M™ Premium Protective Overlay Film Serie 1160 ist nur in Verbindung mit folgenden 3M™ Reflexfolien zugelassen:

- 3M™ High Intensity Grade Prismatic Serie 3930 (RA2, C)
- 3M™ Diamond Grade™ DG3 Serie 4090 (RA3 C)
- der Schutzfilm wird ausschließlich im Fertigungsprozess beim Hersteller aufgebracht

Ihre Vorteile:

- schont die Retroreflexion
- spart Zeit und Kosten, VZ sind schneller wieder einsatzbereit
- verlängert die Lebensdauer der VZ
- nachhaltig, da Abfall vermieden wird



1 l Graffiti-Entferner
Art.-Nr.: ZUB-SONS03
120,60 €

ZUSATZSCHILDER

mit Rand für Beschriftung mit Sondertexten

Gr.-Schl.	Größe in mm	Flachform 2 mm			Flachform 3 mm			Rundform		Alform		
		nicht refl.	RA 1	RA 2	nicht refl.	RA 1	RA 2	RA 1	RA 2	nicht refl.	RA 1	RA 2
.197 0020	...21	...2P	...30	...31	...3P	...91	...9P	...60	...61	...6P
Rechtecke/ Quadrate (Standardgrößen):												
61	231 x 420	21,00	21,00	29,00	27,00	27,00	37,00	38,00	42,00	44,00	44,00	48,00
62	315 x 420	25,00	25,00	34,00	34,00	34,00	44,00	52,00	54,00	51,00	51,00	55,00
71	330 x 600	30,00	30,00	43,00	42,00	42,00	58,00	53,00	56,00	61,00	61,00	66,00
31	333 x 1000	50,00	50,00	67,00	66,00	66,00	86,00	-	-	119,00	119,00	127,00
78	350 x 1050	54,00	54,00	73,00	71,00	71,00	93,00	90,00	94,00	126,00	126,00	135,00
81	412 x 750	48,00	48,00	65,00	62,00	62,00	83,00	80,00	84,00	105,00	105,00	115,00
63	420 x 420	31,00	31,00	43,00	40,00	40,00	53,00	56,00	61,00	60,00	60,00	65,00
72	450 x 600	39,00	39,00	55,00	54,00	54,00	74,00	72,00	76,00	74,00	74,00	80,00
91	462 x 840	59,00	59,00	81,00	82,00	82,00	109,00	-	-	135,00	135,00	142,00
08	500 x 500	36,00	36,00	49,00	50,00	50,00	66,00	56,00	59,00	84,00	84,00	106,00
82	562 x 750	62,00	62,00	84,00	81,00	81,00	108,00	95,00	102,00	130,00	130,00	142,00
25	600 x 600	48,00	48,00	69,00	67,00	67,00	93,00	71,00	78,00	87,00	87,00	97,00
64	630 x 420	43,00	43,00	57,00	55,00	55,00	73,00	70,00	73,00	77,00	77,00	83,00
92	630 x 840	73,00	73,00	101,00	100,00	100,00	134,00	-	-	157,00	157,00	170,00
09	750 x 500	53,00	53,00	73,00	70,00	70,00	93,00	82,00	88,00	114,00	114,00	125,00
13	750 x 750	76,00	76,00	104,00	102,00	102,00	135,00	105,00	116,00	156,00	156,00	171,00
16	840 x 840	95,00	95,00	131,00	127,00	127,00	170,00	131,00	143,00	189,00	189,00	209,00
74	900 x 600	68,00	68,00	98,00	96,00	96,00	133,00	108,00	118,00	118,00	118,00	136,00
94	1260 x 840	-	-	-	181,00	181,00	244,00	-	-	263,00	263,00	294,00
Pfeilwegweiser, einseitig (Standardgrößen):												
.W	250 x 1000	84,00	84,00	113,00	93,00	93,00	124,00	98,00	106,00	177,00	177,00	190,00
22W	350 x 1250	104,00	104,00	145,00	119,00	119,00	164,00	-	-	239,00	239,00	263,00
4W	350 x 1400	109,00	109,00	153,00	125,00	125,00	174,00	143,00	159,00	255,00	255,00	282,00
23W	350 x 1500	116,00	116,00	163,00	134,00	134,00	185,00	-	-	273,00	273,00	302,00
33W	400 x 1500	131,00	131,00	185,00	152,00	152,00	210,00	-	-	310,00	310,00	343,00
34W	400 x 1750	152,00	152,00	215,00	176,00	176,00	244,00	-	-	359,00	359,00	398,00
43W	450 x 1500	147,00	147,00	207,00	170,00	170,00	236,00	-	-	347,00	347,00	384,00
44W	450 x 1750	170,00	170,00	240,00	197,00	197,00	273,00	-	-	403,00	403,00	446,00
.;W	500 x 1750	188,00	188,00	266,00	218,00	218,00	302,00	-	-	446,00	446,00	494,00
7W	500 x 2000	213,00	213,00	302,00	248,00	248,00	344,00	-	-	508,00	508,00	563,00
8W	500 x 2500	-	-	-	307,00	307,00	428,00	-	-	632,00	632,00	700,00
64W	550 x 1750	-	-	-	239,00	239,00	332,00	-	-	489,00	489,00	542,00
65W	550 x 2000	-	-	-	272,00	272,00	378,00	-	-	557,00	557,00	618,00
75W	600 x 2000	-	-	-	296,00	296,00	411,00	-	-	607,00	607,00	673,00
76W	600 x 2250	-	-	-	331,00	331,00	461,00	-	-	681,00	681,00	755,00
86W	700 x 2250	-	-	-	385,00	385,00	537,00	-	-	792,00	792,00	879,00
87W	700 x 2500	-	-	-	427,00	427,00	595,00	-	-	879,00	879,00	975,00
9W	700 x 2800	-	-	-	478,00	478,00	665,00	-	-	983,00	983,00	1.091,00
Pfeilwegweiser, doppelseitig (Standardgrößen):												
.W	250 x 1000	105,00	105,00	143,00	117,00	117,00	172,00	-	-	-	-	-
22W	350 x 1250	140,00	140,00	197,00	161,00	161,00	222,00	-	-	-	-	-
4W	350 x 1400	149,00	149,00	211,00	172,00	172,00	239,00	-	-	-	-	-
23W	350 x 1500	159,00	159,00	225,00	184,00	184,00	256,00	-	-	-	-	-
33W	400 x 1500	181,00	181,00	256,00	209,00	209,00	291,00	-	-	-	-	-
34W	400 x 1750	209,00	209,00	297,00	243,00	243,00	338,00	-	-	-	-	-
43W	450 x 1500	202,00	202,00	286,00	234,00	234,00	326,00	-	-	-	-	-
44W	450 x 1750	234,00	234,00	332,00	272,00	272,00	379,00	-	-	-	-	-
.;W	500 x 1750	260,00	260,00	368,00	301,00	301,00	419,00	-	-	-	-	-
7W	500 x 2000	296,00	296,00	419,00	343,00	343,00	478,00	-	-	-	-	-
8W	500 x 2500	-	-	-	427,00	427,00	595,00	-	-	-	-	-
64W	550 x 1750	-	-	-	331,00	331,00	460,00	-	-	-	-	-
65W	550 x 2000	-	-	-	377,00	377,00	525,00	-	-	-	-	-
75W	600 x 2000	-	-	-	410,00	410,00	572,00	-	-	-	-	-
76W	600 x 2250	-	-	-	461,00	461,00	642,00	-	-	-	-	-

ZUSATZSCHILDER mit Rand für Beschriftung mit Sondertexten

Gr.-Schl.	Größe in mm	Flachform 2 mm			Flachform 3 mm			Rundform		Alform		
		nicht refl.	RA 1	RA 2	nicht refl.	RA 1	RA 2	RA 1	RA 2	nicht refl.	RA 1	RA 2
	.197 0020	...21	...2P	...30	...31	...3P	...91	...9P	...60	...61	...6P
86W	700 x 2250	-	-	-	536,00	536,00	747,00	-	-	-	-	-
87W	700 x 2500	-	-	-	595,00	595,00	829,00	-	-	-	-	-
9W	700 x 2800	-	-	-	665,00	665,00	927,00	-	-	-	-	-
Rechtecke/ Quadrate (Sondergrößen):												
01	150 x 300	26,00	26,00	27,00	27,00	27,00	29,00	-	-	30,00	30,00	32,00
03	250 x 300	32,00	32,00	34,00	34,00	34,00	37,00	-	-	40,00	40,00	42,00
04	250 x 500	42,00	42,00	47,00	47,00	47,00	51,00	-	-	55,00	55,00	60,00
14	250 x 1000	68,00	68,00	77,00	77,00	77,00	86,00	-	-	94,00	94,00	103,00
40	275 x 500	45,00	45,00	50,00	50,00	50,00	54,00	-	-	59,00	59,00	64,00
41	325 x 600	57,00	57,00	64,00	64,00	64,00	70,00	-	-	77,00	77,00	84,00
05	350 x 500	53,00	53,00	59,00	59,00	59,00	65,00	-	-	71,00	71,00	77,00
06	350 x 750	71,00	71,00	80,00	80,00	80,00	89,00	-	-	98,00	98,00	107,00
07	350 x 1000	73,00	73,00	85,00	85,00	85,00	98,00	-	-	110,00	110,00	122,00
24	400 x 400	50,00	50,00	55,00	55,00	55,00	61,00	-	-	66,00	66,00	72,00
42	425 x 600	69,00	69,00	78,00	78,00	78,00	87,00	-	-	96,00	96,00	105,00
10	500 x 1000	-	-	-	122,00	122,00	139,00	-	-	156,00	156,00	174,00
43	525 x 600	82,00	82,00	93,00	93,00	93,00	104,00	-	-	114,00	114,00	125,00
11	650 x 1000	-	-	-	158,00	158,00	181,00	-	-	203,00	203,00	226,00
17	1000 x 1000	-	-	-	243,00	243,00	278,00	-	-	312,00	312,00	347,00
Pfeilwegweiser, einseitig (Sondergrößen):												
1W	200 x 750	70,00	70,00	93,00	76,00	76,00	99,00	-	-	140,00	140,00	149,00
2W	200 x 1000	81,00	81,00	109,00	89,00	89,00	118,00	-	-	167,00	167,00	179,00
3W	333 x 1250	110,00	110,00	153,00	125,00	125,00	172,00	-	-	252,00	252,00	277,00
AW	333 x 1500	129,00	129,00	180,00	147,00	147,00	203,00	-	-	297,00	297,00	327,00
5W	333 x 1750	140,00	140,00	198,00	162,00	162,00	225,00	-	-	331,00	331,00	367,00
Pfeilwegweiser, doppelseitig (Sondergrößen):												
1W	200 x 750	84,00	84,00	112,00	92,00	92,00	112,00	-	-	-	-	-
2W	200 x 1000	100,00	100,00	134,00	110,00	110,00	147,00	-	-	-	-	-
3W	333 x 1250	147,00	147,00	207,00	169,00	169,00	234,00	-	-	-	-	-
AW	333 x 1500	174,00	174,00	244,00	200,00	200,00	276,00	-	-	-	-	-
5W	333 x 1750	193,00	193,00	273,00	224,00	224,00	311,00	-	-	-	-	-

Zusatzschilder beschriftet mit Sondertext (maximal 3 Zeilen)												
Gr.-Schl.	Größe in mm	Flachform 2 mm			Flachform 3 mm			Rundform		Alform		
		nicht refl.	RA 1	RA 2	nicht refl.	RA 1	RA 2	RA 1	RA 2	nicht refl.	RA 1	RA 2
	.199 0020	...21	...2P	...30	...31	...3P	...91	...9P	...60	...61	...6P
61	231 x 420	40,00	40,00	48,00	46,00	46,00	56,00	57,00	61,00	63,00	63,00	67,00
62	315 x 420	45,00	45,00	54,00	54,00	54,00	64,00	72,00	74,00	71,00	71,00	75,00
63	420 x 420	52,00	52,00	64,00	61,00	61,00	74,00	77,00	82,00	81,00	81,00	86,00
64	630 x 420	65,00	65,00	79,00	77,00	77,00	95,00	92,00	95,00	99,00	99,00	105,00
71	330 x 600	51,00	51,00	64,00	63,00	63,00	79,00	74,00	77,00	82,00	82,00	87,00
72	450 x 600	61,00	61,00	77,00	76,00	76,00	96,00	94,00	98,00	96,00	96,00	102,00
25	600 x 600	75,00	75,00	96,00	94,00	94,00	120,00	98,00	105,00	114,00	114,00	124,00
74	900 x 600	98,00	98,00	128,00	126,00	126,00	163,00	138,00	148,00	148,00	148,00	166,00
81	412 x 750	75,00	75,00	92,00	89,00	89,00	110,00	107,00	111,00	132,00	132,00	142,00
82	562 x 750	90,00	90,00	112,00	109,00	109,00	136,00	123,00	130,00	158,00	158,00	170,00
13	750 x 750	106,00	106,00	134,00	132,00	132,00	165,00	135,00	146,00	186,00	186,00	201,00
16	840 x 840	128,00	128,00	164,00	160,00	160,00	203,00	164,00	176,00	222,00	222,00	242,00
94	1260 x 840	-	-	-	219,00	219,00	282,00	-	-	301,00	301,00	332,00

KLAPPSCHILDER, MECHANISCH PRISMENSCHILDER

Klappschild, einfach: Standard-Verkehrszeichen, Teilung horizontal (im geschl. Zustand nur halbes Schild sichtbar)

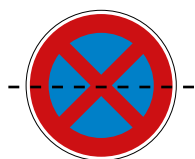

Schelle zur Mastbefestigung
siehe Seite 179

		2 mm				3 mm			
		RA1		RA2		RA1		RA2	
Ronden									
Größe	Verschluss	Art-Nr.	Preis	Art-Nr.	Preis	Art-Nr.	Preis	Art-Nr.	Preis
Ø 420	Schnäpper	.191 10.4D21S	73,50	.191 10.4D2PS	79,10	.191 10.4D31S	78,90	.191 10.4D3PS	84,50
	Vorreiber	.191 10.4D21V	64,60	.191 10.4D2PV	70,10	.191 10.4D31V	70,00	.191 10.4D3PV	75,40
Ø 600	Schnäpper	.191 1006D21S	90,60	.191 1006D2PS	101,30	.191 1006D31S	101,50	.191 1006D3PS	112,30
	Vorreiber	.191 1006D21V	81,50	.191 1006D2PV	92,30	.191 1006D31V	92,60	.191 1006D3PV	103,30
Ø 750	Schnäpper	.191 1007D21S	109,80	.191 1007D2PS	127,50	.191 1007D31S	126,90	.191 1007D3PS	144,60
	Vorreiber	.191 1007D21V	100,70	.191 1007D2PV	118,50	.191 1007D31V	118,00	.191 1007D3PV	135,60
Quadrate									
Größe	Verschluss	Art-Nr.	Preis	Art-Nr.	Preis	Art-Nr.	Preis	Art-Nr.	Preis
420 x 420	Schnäpper	.191 1006321S	77,50	.191 100632PS	84,60	.191 1006331S	84,40	.191 100633PS	91,40
	Vorreiber	.191 1006321V	68,50	.191 100632PV	75,60	.191 1006331V	75,40	.191 100633PV	82,50
600 x 600	Schnäpper	.191 1002521S	98,50	.191 100252PS	112,20	.191 1002531S	112,40	.191 100253PS	126,20
	Vorreiber	.191 1002521V	89,50	.191 100252PV	103,30	.191 1002531V	103,50	.191 100253PV	117,10
750 x 750	Schnäpper	.191 1001321S	122,00	.191 100132PS	144,80	.191 1001331S	144,10	.191 100133PS	166,70
	Vorreiber	.191 1001321V	112,90	.191 100132PV	135,80	.191 1001331V	135,10	.191 100133PV	157,70
Rechtecke									
Größe	Verschluss	Art-Nr.	Preis	Art-Nr.	Preis	Art-Nr.	Preis	Art-Nr.	Preis
231x420	Schnäpper	.191 1006121S	68,80	.191 100612PS	72,70	.191 1006131S	72,50	.191 100613PS	76,40
	Vorreiber	.191 1006121V	59,80	.191 100612PV	63,70	.191 1006131V	63,60	.191 100613PV	67,50
315x420	Schnäpper	.191 1006221S	73,70	.191 100622PS	78,90	.191 1006231S	78,80	.191 100623PS	84,00
	Vorreiber	.191 1006221V	64,60	.191 100622PV	70,00	.191 1006231V	69,80	.191 100623PV	75,00
330x600	Schnäpper	.191 1007121S	81,30	.191 100712PS	88,90	.191 1007131S	89,00	.191 100713PS	96,50
	Vorreiber	.191 1007121V	72,40	.191 100712PV	80,00	.191 1007131V	80,10	.191 100713PV	87,60
630x420	Schnäpper	.191 1006421S	90,20	.191 100642PS	100,80	.191 1006431S	100,50	.191 100643PS	111,10
	Vorreiber	.191 1006421V	81,30	.191 100642PV	91,90	.191 1006431V	91,50	.191 100643PV	102,10
450x600	Schnäpper	.191 1007221S	91,10	.191 100722PS	101,50	.191 1007231S	101,60	.191 100723PS	111,90
	Vorreiber	.191 1007221V	82,20	.191 100722PV	92,40	.191 1007231V	92,70	.191 100723PV	102,90
900x600	Schnäpper	.191 1007421S	120,50	.191 100742PS	141,10	.191 1007431S	141,50	.191 100743PS	162,10
	Vorreiber	.191 1007421V	111,50	.191 100742PV	132,00	.191 1007431V	132,50	.191 100743PV	153,00

Sondergrößen sowie andere Folien auf Anfrage (Aufpreis für Konstruktion und Arbeitsvorbereitung)

Klappschild, Buchform, Standard, Teilung horizontal oder vertikal

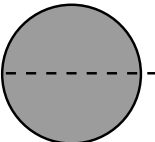
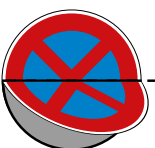

		2 mm				3 mm				Alform			
		RA1		RA2		RA1		RA2		RA1		RA2	
Ronden													
Größe	Verschluss	Art-Nr.	Preis	Art-Nr.	Preis	Art-Nr.	Preis	Art-Nr.	Preis	Art-Nr.	Preis	Art-Nr.	Preis
Ø 420	Schnäpper	.191B10.4D21S	96,20	.191B10.4D2PS	104,50	.191B10.4D31S	104,30	.191B10.4D3PS	112,60	.191B10.4D61S	104,20	.191B10.4D6PS	112,50
	Vorreiber	.191B10.4D21V	87,30	.191B10.4D2PV	95,60	.191B10.4D31V	95,30	.191B10.4D3PV	103,60	.191B10.4D61V	95,20	.191B10.4D6PV	103,50
Ø 600	Schnäpper	.191B1006D21S	120,60	.191B1006D2PS	136,80	.191B1006D31S	137,10	.191B1006D3PS	153,10	.191B1006D61S	128,90	.191B1006D6PS	145,40
	Vorreiber	.191B1006D21V	111,60	.191B1006D2PV	127,70	.191B1006D31V	128,00	.191B1006D3PV	144,10	.191B1006D61V	119,90	.191B1006D6PV	136,30
Ø 750	Schnäpper	.191B1007D21S	148,20	.191B1007D2PS	174,80	.191B1007D31S	173,90	.191B1007D3PS	200,50	.191B1007D61S	162,00	.191B1007D6PS	188,40
	Vorreiber	.191B1007D21V	139,20	.191B1007D2PV	165,70	.191B1007D31V	164,90	.191B1007D3PV	191,50	.191B1007D61V	152,90	.191B1007D6PV	179,50
Quadrate													
Größe	Verschluss	Art-Nr.	Preis	Art-Nr.	Preis	Art-Nr.	Preis	Art-Nr.	Preis	Art-Nr.	Preis	Art-Nr.	Preis
420 x 420	Schnäpper	.191B1006321S	102,20	.191B100632PS	112,80	.191B1006331S	112,50	.191B100633PS	123,10	.191B1006361S	112,20	.191B100636PS	122,80
	Vorreiber	.191B1006321V	93,30	.191B100632PV	103,80	.191B1006331V	103,50	.191B100633PV	114,10	.191B1006361V	103,30	.191B100636PV	113,90
600 x 600	Schnäpper	.191B1002521S	132,50	.191B100252PS	153,10	.191B1002531S	153,50	.191B100253PS	174,00	.191B1002561S	144,80	.191B100256PS	165,40
	Vorreiber	.191B1002521V	123,50	.191B100252PV	144,10	.191B1002531V	144,40	.191B100253PV	165,00	.191B1002561V	135,90	.191B100256PV	156,50
750 x 750	Schnäpper	.191B1001321S	167,00	.191B100132PS	200,80	.191B1001331S	199,80	.191B100133PS	233,60	.191B1001361S	182,00	.191B100136PS	215,80
	Vorreiber	.191B1001321V	158,00	.191B100132PV	191,80	.191B1001331V	190,70	.191B100133PV	224,50	.191B1001361V	173,00	.191B100136PV	206,90

Fortsetzung nächste Seite

KLAPPSCHILDER, MECHANISCH PRISMENSCHILDER

klappschild, einfach, Wegweiser, Teilung vertikal, (im geschl. Zustand nur halbes Schild sichtbar)

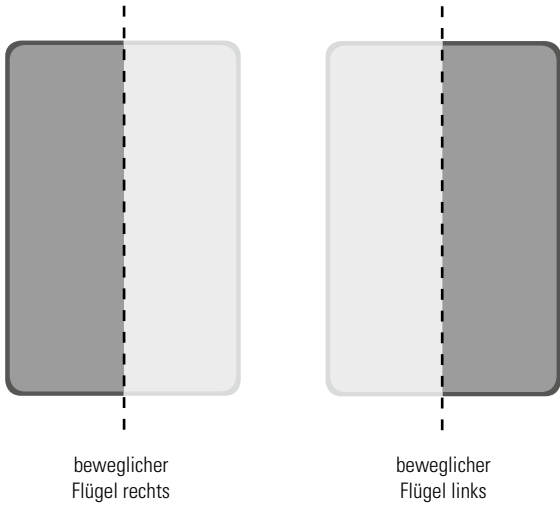

Einhandverriegelung für Wegweiser- und Umleitungsbeschilderung: vertikal geteilt

Rückansicht im aufgeklappten Zustand

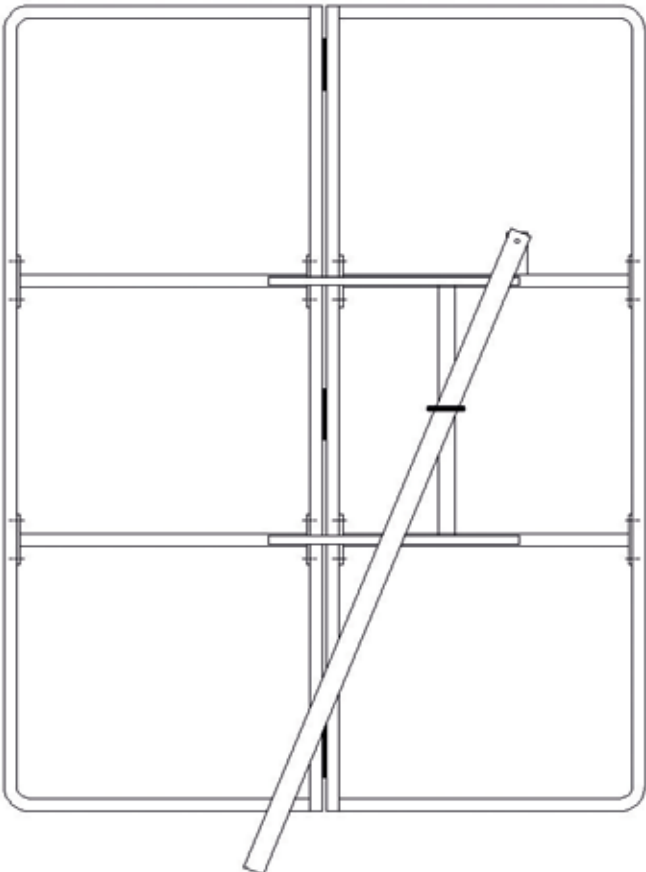

		Alform II		
		RA2	RA3	
Rechtecke				
Größe	Art-Nr.	Preis	Art-Nr.	Preis
800x800	.191R108087P1	566,50	.191R10808731	595,10
	.191L108087P1		.191L10808731	
1000x1000	.191R110107P1	645,30	.191R11010731	689,80
	.191L110107P1		.191L11010731	
1600x800	.191R116087P1	824,60	.191R11608731	1.001,30
	.191L116087P1		.191L11608731	
1800x800	.191R118087P1	984,70	.191R11808731	1.048,90
	.191L118087P1		.191L11808731	
1600x1250	.191R116127P1	1.095,40	.191R11612731	1.184,70
	.191L116127P1		.191L11612731	
2000 x 1250	.191R120127P1	1.139,10	.191R12012731	1.250,50
	.191L120127P1		.191L12012731	
2500x1750	.191R125177P1	1.590,40	.191R12517731	1.785,50
	.191L125177P1		.191L12517731	
Sondergrößen sowie andere Folien auf Anfrage (Aufpreis für Konstruktion und Arbeitsvorbereitung)				

- Teilung vertikal
- Verschluss aus verzinktem Stahl



Klappschild, Buchform, Wegweiser, Teilung vertikal

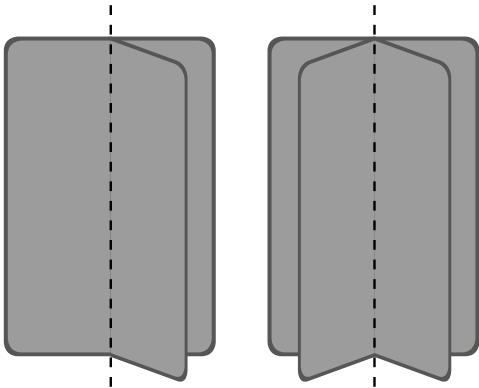

Alform 2								
einflügelig			zweiflügelig					
RA2		RA3		RA2		RA3		
Rechtecke								
Größe	Art-Nr.	Preis	Art-Nr.	Preis	Art-Nr.	Preis	Art-Nr.	Preis
1600x1250	.191B116127P2	930,70	.191B11612732	1.064,40	.191B216127P2	1.093,20	.191B21612732	1.272,60
2000x1250	.191B120127P2	1.042,90	.191B12012732	1.210,00	.191B220127P2	1.314,60	.191B22012732	1.537,60
Sondergrößen sowie andere Folien auf Anfrage								

- Teilung vertikal
- Verschluss aus Edelstahl

Verriegelungsmechanismus für
Buchform mit Edelstahlverriegelung und Grundplatte

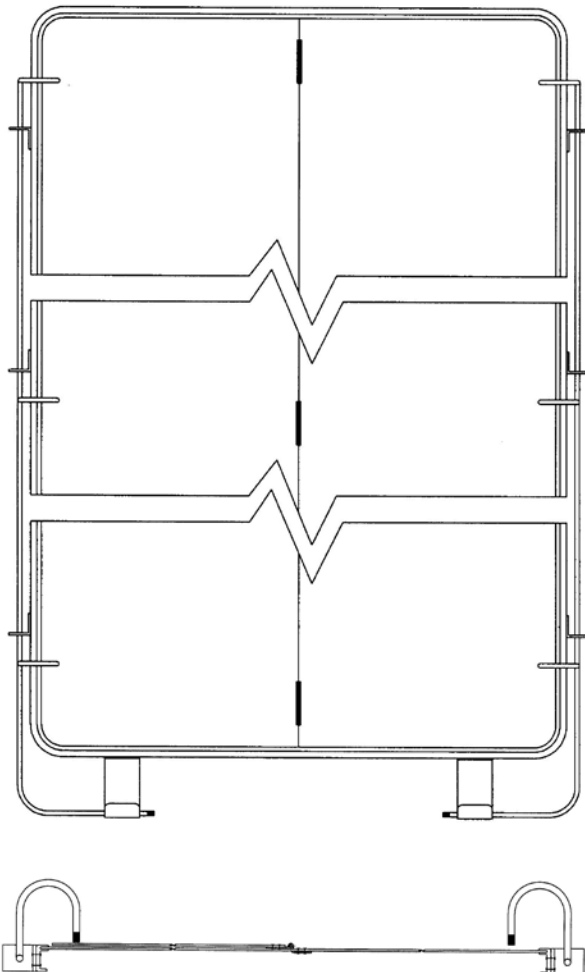

KLAPPSCHILDER, MECHANISCH PRISMENSCHILDER

Steighilfe (zur festen Montage am Rohrmast)

aus Stahl, feuerverzinkt. Lieferung inklusive Zubehörset MK-10015 (4 Sechskantschrauben M 10 x 50, A2-70, ISO 4017, 8 Sechskantmuttern M 10, A2-70, ISO 4032 und 8 Unterlegscheiben Form A für M 10, A2-70, ISO 7089)



213,70
SH-0000010



163,70
SH-0000020



86,00
SH-0000030



Aufstiegshilfe für Gittermaste: auf Anfrage

Der Preis des Artikels
SH-0000030 bezieht sich auf
"eine Ecke".

Prismenschilder



Bild 1



Bild 2



Bild 3

Zubehör:
Photovoltaikanlage
Funkanlage
Handsender
Datenausgabegerät

Prismenschilder bieten wir in folgenden Standardgrößen an:
(angegebene Größen sind Sichtmaße)

943 x 900 mm

1260 x 900 mm

1681 x 900 mm

2630 x 900 mm

2841 x 900 mm

3262 x 900 mm

bzw. 2630 x 1400 mm

bzw. 2841 x 1400 mm

bzw. 3262 x 1400 mm

Ohne Aufstellvorrichtung; Pulverbeschichtung nach RAL, Preise auf Anfrage

Windkraftanlagen

Vertikal-Klein-Windkraft-Anlagen / (Vertikalachsläufer) - Darrieus



Vertikal-Klein-Windkraft-Anlagen / (Vertikalachsläufer) - H-Rotor



Das Netzunabhängige Autobahnwarnschild weist - je nach Display - heranfahrende Fahrzeuge aufmerksamkeitsstark auf Verkehrsbeeinflussungen, wie z.B. Geschwindigkeitsbegrenzungen oder Staus hin. Die Schilder befinden sich im Standby-Modus und können - je nach Ausführung - durch Fernsteuerung einer Autobahnmeisterei, BAG oder der Polizei aktiviert werden. Die autarke Stromversorgung ermöglicht eine sofortige Zuschaltung und einen durchgängigen Betrieb im Standby-Modus. Das System ist modular aufgebaut und wird nach Ihren Vorstellungen integriert.

Produktzusammenfassung:

- Energieautark betriebsfähig
- LED-Schild mit Bast-Verkehrsschildern
- Stromerzeugung für netzunabhängigen Betrieb, Energiespeicher integriert
- ganzjähriger Stand-By-Modus möglich
- zentrale Ansteuermöglichkeit
- Aufstellung: Rohrmast inkl. Fundament

Preise auf Anfrage

Einsatzbereich	BAB und Straßen jeglicher Art (z.B. BAG-, Zoll- und Polizei-kontrollstellen (< 8 h kein Dauerbetrieb)
Betriebsspannung	230 V am Masterschild/ WKA 48 V am zweiten Schild, Stromversorgung über Niederspannungskabel in der Fahrbahn
Steuerung	Variante 1 - Handfunk- / Autofunksender Variante 2 - Schlüsselschalter am Schild Variante 3 - zentrale Steuereinheit
Stromerzeugung	12 V über Windkraftanlage, z.B. 500 Wp und Solarpanel
Stromspeicher	2 x 84 Ah Akku
Aufstellung	Rohrmast inklusive Fundament

VERKEHRSLEITSÄULE

Eine Verkehrsleitsäule ist eine Verkehrsschildkombination.

Sie besteht oben aus einem Verkehrszeichen 222-10 oder 222 und unten aus einem Verkehrszeichen 626-10 oder 626-20.

Beide Verkehrszeichen sind an einem Rohrfosten aus Aluminium Ø 60 mm, 2250 mm oder 2000 mm lang, montiert.

Verkehrsleitsäule: Ausführung A

- oben: - Rundformschild, Ø 600 mm
 - am Pfosten montiert mit 2 Super-Klemmschellen (RSK 60)
- unten: - **zylindrisch-elliptische** Form (oben und unten offen), 750 x 500 mm
 - am Pfosten montiert mit 2 Sonderrohrschellen (R-S194)

Rohrfostenlänge 2250 mm



linksweisend				
oben:		VZ 222-10		
unten:	Vorderseite	VZ 626-10		
	Rückseite	VZ 626-10		
Folie:	RA 2		EM10106D9P	381,40
	RA 3		EM10106D93	425,60

rechtsweisend				
oben:		VZ 222		
unten:	Vorderseite	VZ 626-20		
	Rückseite	VZ 626-20		
Folie:	RA 2		EM20206D9P	381,40
	RA 3		EM20206D93	425,60

oben:		VZ 222-10		
unten:	Vorderseite	VZ 626-10		
	Rückseite	grau		
Folie:	RA 2		EM10006D9P	361,80
	RA 3		EM10006D93	390,80

oben:		VZ 222		
unten:	Vorderseite	VZ 626-20		
	Rückseite	grau		
Folie:	RA 2		EM20006D9P	361,80
	RA 3		EM20006D93	390,80

Verkehrsleitsäule: Ausführung B

- oben: - Alformschild, Ø 600 mm
 - am Pfosten montiert mit 2 Alform-Klemmschellen (RKS 60)
- unten: - **Alformschild, gerade Form** (hinten offen), 750 x 500 mm
 - am Pfosten montiert mit 2 Alform-Klemmschellen (RKS 60)

Rohrfostenlänge 2250 mm



linksweisend				
oben:		VZ 222-10		
unten:	Vorderseite	VZ 626-10		
	Rückseite	grau		
Folie:	RA 2		FM10006D9P	245,40
	RA 3		FM10006D93	275,30

rechtsweisend				
oben:		VZ 222		
unten:	Vorderseite	VZ 626-20		
	Rückseite	grau		
Folie:	RA 2		FM20006D9P	245,40
	RA 3		FM20006D93	275,30

Verkehrsleitsäule: Ausführung C

- oben: - Flachschild, 2 mm Alu, Ø 600 mm
- am Pfosten montiert mit 2 Rohrschellen (R-R107)
- unten: - Flachschild, 2 mm Alu, konvexe Form (hinten offen), mit Kantenschutz, 750 x 500 mm
- am Pfosten montiert mit 2 Sonderrohrschildern (R-S195)

Rohrpfostenlänge 2250 mm



linksweisend				
oben:		VZ 222-10		
unten:	Vorderseite	VZ 626-10		
	Rückseite	grau		
Folie:	RA 2		GM10006D9P	237,50
	RA 3		GM10006D93	266,60

rechtsweisend				
oben:		VZ 222		
unten:	Vorderseite	VZ 626-20		
	Rückseite	grau		
Folie:	RA 2		GM20006D9P	237,50
	RA 3		GM20006D93	266,60

Verkehrsleitsäule: Ausführung D

- oben: - Alformschild, Ø 600 mm
- am Pfosten montiert mit 2 Alform-Klemmschellen (RKS 60)
- unten: - runder Verkehrszeichenkörper, Höhe 600 mm, Ø 300 mm
- am Pfosten montiert mit 2 Sonderrohrschildern (R-S196)

Rohrpfostenlänge 2000 mm



linksweisend				
oben:		VZ 222-10		
unten:	Vorderseite	VZ 626-10		
Folie:	RA 2		EI10106D9P	293,90
	RA 3		EI10106D93	325,70

rechtsweisend				
oben:		VZ 222		
unten:	Vorderseite	VZ 626-20		
Folie:	RA 2		EI20206D9P	293,90
	RA 3		EI20206D93	325,70

Diese Verkehrsleitsäule ist auch oben und unten geschlossen lieferbar.
Aufpreis pro Deckel (Es werden zwei Deckel benötigt):

EI999-0010 68,80

Verkehrsleitsäule: Ausführung E

- oben: - Alformschild, Ø 600 mm
- am Pfosten montiert mit 2 Alform-Klemmschellen (RKS 60)
- unten: - runder Verkehrszeichenkörper, Höhe 600 mm, Ø 150 mm
- am Pfosten montiert mit 2 Sonderrohrschildern

Rohrpfostenlänge 2000 mm





linksweisend				
oben:		VZ 222-10		
unten:	Vorderseite	VZ 626-10		
Folie:	RA 2		EL10106D9P	263,80
	RA 3		EL10106D93	286,50

rechtsweisend				
oben:		VZ 222		
unten:	Vorderseite	VZ 626-20		
Folie:	RA 2		EL20206D9P	263,80
	RA 3		EL20206D93	286,50

VERKEHRSLEITSÄULE

Neben dem Kopfzeichen 222-10 bzw. 222 und dem Rohrpfosten sind folgende speziellen Einzelteile lieferbar:











Zu Ausführung A:				
zylindrisch-elliptischer Körper, 750 x 500 mm,				
Vorder- u. Rückseite mit Zeichen 626-10,	Folie RA2,		EM10P-1010	189,20
Vorder- u. Rückseite mit Zeichen 626-20,	Folie RA2,		EM10P-2020	189,20
Vorder- u. Rückseite mit Zeichen 626-10,	Folie RA3,		EM103-1010	219,70
Vorder- u. Rückseite mit Zeichen 626-20,	Folie RA3,		EM103-2020	219,70
Vorderseite mit Zeichen 626-10,	Folie RA2,	RS grau	EM10P-1000	169,70
Vorderseite mit Zeichen 626-20,	Folie RA2,	RS grau	EM10P-2000	169,70
Vorderseite mit Zeichen 626-10,	Folie RA3,	RS grau	EM103-1000	184,90
Vorderseite mit Zeichen 626-20,	Folie RA3,	RS grau	EM103-2000	184,90
Sonderschelle zur Befestigung am Pfosten, Ø 60 mm (Zur Befestigung des zylindrisch-elliptischen Körpers werden 2 Stück benötigt.)			R-S194	22,30
Zu Ausführung B: Zeichen 626-10, bzw. Zeichen 626-20 finden Sie im vorhergehenden Verkehrszeichenteil unter der entsprechenden StVO-Nummer.				
Zu Ausführung C:				
Flachschild 2 mm, 750 x 500 mm, konvex, mit Kantenschutz,	Zeichen 626-10	Folie RA2	EM100-092P	123,20
	Zeichen 626-20	Folie RA2	EM200-092P	123,20
	Zeichen 626-10	Folie RA3	EM100-0923	138,40
	Zeichen 626-20	Folie RA3	EM200-0923	138,40
Sonderschelle zur Befestigung am Pfosten, Ø 60 mm, inklusive 2 Sechskantschrauben M8x25, A2-70, ISO 4017 und 2 Sechskantmutter M8, A2-70, ISO 4032 (Zur Befestigung der Zeichen 626-10/-20 werden pro Leitsäule 2 Stück benötigt.)			R-S195	11,80
Zu Ausführung D:				
runder Körper, 600 x 300 mm,	Zeichen 626-10	Folie RA2	EI10P-1010	154,40
	Zeichen 626-20	Folie RA2	EI10P-2020	154,40
	Zeichen 626-10	Folie RA3	EI103-1010	172,70
	Zeichen 626-20	Folie RA3	EI103-2020	172,70
Sonderschelle zur Befestigung am Pfosten, Ø 60 mm (Zur Befestigung des runden Körpers werden 2 Stück benötigt.)			R-S196	12,20
Zu Ausführung E:				
runder Körper, 600 x 150 mm,	Zeichen 626-10	Folie RA2	EL10P-1010	122,20
	Zeichen 626-20	Folie RA2	EL10P-2020	122,20
	Zeichen 626-10	Folie RA3	EL103-1010	131,30
	Zeichen 626-20	Folie RA3	EL103-2020	131,30
Sonderschelle zur Befestigung am Pfosten, Ø 60 mm (Zur Befestigung des runden Körpers werden 2 Stück benötigt.)			R-S190	15,10

Leitzylinder (Ø 150 mm, Höhe 1000 mm, blau-weiß/rot-weiß, inkl. integr. Befestigungsschellen + Kantenschutz, ohne Deckel)



Blau-weiß	für Rohr-Durchmesser 60 mm	Folie RA2	LZ.00001	167,20
	für Rohr-Durchmesser 60 mm	Folie RA3	LZ.00002	182,40
	für Rohr-Durchmesser 76 mm	Folie RA2	LZ.00003	167,20
	für Rohr-Durchmesser 76 mm	Folie RA3	LZ.00004	182,40
Rot-weiß	für Rohr-Durchmesser 60 mm	Folie RA2	LZ.00005	167,20
	für Rohr-Durchmesser 60 mm	Folie RA3	LZ.00006	182,40
	für Rohr-Durchmesser 76 mm	Folie RA2	LZ.00007	167,20
	für Rohr-Durchmesser 76 mm	Folie RA3	LZ.00008	182,40

Dieser Leitzylinder wird speziell bei der Sicherung von Fußgängerüberwegen eingesetzt

Ausführung	Größe in mm	Flachform 2 mm		Flachform 3 mm		Rundform		Alform	
		Folie RA1	Folie RA2	Folie RA1	Folie RA2	Folie RA1	Folie RA2	Folie RA1	Folie RA2
einseitig									
	150 x 300	24,00 00KM 01 0121	26,00 00KM 01 012P	26,00 00KM 01 0131	27,00 00KM 01 013P	-	-	29,00 00KM 01 0161	30,00 00KM 01 016P
	200 x 324	28,00 00KM 11 9921	30,00 00KM 11 992P	30,00 00KM 11 9931	33,00 00KM 11 993P	-	-	-	-
	220 x 400	33,00 00KM 01 2821	36,00 00KM 01 282P	36,00 00KM 01 2831	39,00 00KM 01 283P	39,00 00KM 01 2891	42,00 00KM 01 289P	42,00 00KM 01 2861	45,00 00KM 01 286P
	260 x 450	39,00 00KM 01 3321	43,00 00KM 01 332P	43,00 00KM 01 3331	46,00 00KM 01 333P	-	-	50,00 00KM 01 3361	54,00 00KM 01 336P
	260 x 550	44,00 00KM 01 2921	49,00 00KM 01 292P	49,00 00KM 01 2931	53,00 00KM 01 293P	53,00 00KM 01 2991	58,00 00KM 01 299P	58,00 00KM 01 2961	63,00 00KM 01 296P
	350 x 500	50,00 00KM 01 0521	56,00 00KM 01 052P	56,00 00KM 01 0531	62,00 00KM 01 053P	-	-	67,00 00KM 01 0561	73,00 00KM 01 056P
abgekantet, doppelseitig									
	200 x 324	47,00 00KM 11 99A1	56,00 00KM 11 99AP	-	-	-	-	-	-
	220 x 400	57,00 00KM 00 2821	69,00 00KM 00 282P	-	-	-	-	-	-
Auf Kundenwunsch liefern wir Ihnen die Kilometertafeln auch fertig montiert an Stahl- oder Aluminium-Rohrpfosten (Preis auf Anfrage). Außerdem sind Einzelfoliebuchstaben für die Kilometertafeln lieferbar.									
  	900 x 600	107,00 .190 00 7421	125,00 .190 00 742P	125,00 .190 00 7431	143,00 .190 00 743P	-	-	161,00 .190 00 7461	179,00 .190 00 746P
	1600 x 1250	396,00 .190 00 9521	462,00 .190 00 952P	462,00 .190 00 9531	528,00 .190 00 953P	-	-	594,00 .190 00 9561	660,00 .190 00 956P
		Schilder der Ausführung „Flachform 2 mm“ entsprechen in der Größe 1600 x 1250 nicht der RAL-Gütezeichenvorschrift.							
		Weitere Varianten auf Kundenwunsch möglich.							

Sonderrohrrahmen für Kilometertafeln

Standrohrdurchmesser 48 mm, Bodenfreiheit 1000 mm	für Schildgröße 150 x 300 mm	AES01551	95,60
	für Schildgröße 260 x 550 mm	AES02551	103,10

FOLIENBUCHSTABEN

Buchstabenhöhe in mm	schwarz (nicht refl.)	farbig		
		EC-Film	Reflexfolie RA 1	Reflexfolie RA 2
10 - 20	0,50 CS2 020S-00	-	-	-
21 - 30	0,50 CS2 030S-00	0,70 CS2 030E-00	-	-
31 - 40	0,50 CS2 040S-00	0,70 CS2 040E-00	0,70 CS2 040I-00	-
41 - 50	0,50 CS2 050S-00	0,70 CS2 050E-00	0,70 CS2 050I-00	1,40 CS2 0502-00
51 - 60	0,50 CS2 060S-00	0,70 CS2 060E-00	0,70 CS2 060I-00	1,40 CS2 0602-00
61 - 70	0,60 CS2 070S-00	0,90 CS2 070E-00	0,90 CS2 070I-00	1,90 CS2 0702-00
71 - 80	0,80 CS2 080S-00	1,20 CS2 080E-00	1,20 CS2 080I-00	2,40 CS2 0802-00
81 - 90	1,00 CS2 090S-00	1,50 CS2 090E-00	1,50 CS2 090I-00	3,10 CS2 0902-00
91 - 100	1,10 CS2 100S-00	1,60 CS2 100E-00	1,60 CS2 100I-00	3,20 CS2 1002-00
101 - 120	1,15 CS2 120S-00	1,65 CS2 120E-00	1,65 CS2 120I-00	3,25 CS2 1202-00
121 - 140	1,25 CS2 140S-00	1,75 CS2 140E-00	1,75 CS2 140I-00	3,70 CS2 1402-00
141 - 160	1,60 CS2 160S-00	2,30 CS2 160E-00	2,30 CS2 160I-00	4,80 CS2 1602-00
161 - 180	2,00 CS2 180S-00	2,90 CS2 180E-00	2,90 CS2 180I-00	6,10 CS2 1802-00
181 - 200	2,50 CS2 200S-00	3,60 CS2 200E-00	3,60 CS2 200I-00	7,60 CS2 2002-00
201 - 250	3,90 CS2 250S-00	5,60 CS2 250E-00	5,60 CS2 250I-00	11,75 CS2 2502-00
251 - 300	5,55 CS2 300S-00	8,10 CS2 300E-00	8,10 CS2 300I-00	16,90 CS2 3002-00
301 - 350	7,60 CS2 350S-00	10,95 CS2 350E-00	10,95 CS2 350I-00	23,00 CS2 3502-00
351 - 400	9,90 CS2 400S-00	14,30 CS2 400E-00	14,30 CS2 400I-00	30,10 CS2 4002-00
401 - 450	12,50 CS2 450S-00	18,10 CS2 450E-00	18,10 CS2 450I-00	38,10 CS2 4502-00
451 - 500	15,45 CS2 500S-00	22,35 CS2 500E-00	22,35 CS2 500I-00	46,95 CS2 5002-00

Die Folienbuchstaben werden mit Übertragungsfolie geliefert.

Der EC-Film ist nur in den Farben Rot, Grün, Blau, Braun und Gelb lieferbar.

Größe in mm	mit Übertragungsfolie				auf Grundfolie			
	schwarz (nicht refl.)	farbig			schwarz (nicht refl.)	farbig		
		EC-Film	Reflexfolie RA1	Reflexfolie RA2		EC-Film	Reflexfolie RA1	Reflexfolie RA2
100 x 100	4,65 DS00 1010S0	7,15 DS00 1010E0	7,15 DS00 1010I0	16,00 DS00 1010Z0	6,05 D000 1010S0	9,90 D000 1010E0	9,90 D000 1010I0	23,70 D000 1010Z0
120 x 120	4,65 DS00 1212S0	7,15 DS00 1212E0	7,15 DS00 1212I0	16,00 DS00 1212Z0	6,05 D000 1212S0	9,90 D000 1212E0	9,90 D000 1212I0	23,70 D000 1212Z0
150 x 150	4,65 DS00 1515S0	7,15 DS00 1515E0	7,15 DS00 1515I0	16,00 DS00 1515Z0	6,05 D000 1515S0	9,90 D000 1515E0	9,90 D000 1515I0	23,70 D000 1515Z0
200 x 200	4,65 DS00 2020S0	7,15 DS00 2020E0	7,15 DS00 2020I0	16,00 DS00 2020Z0	6,05 D000 2020S0	9,90 D000 2020E0	9,90 D000 2020I0	23,70 D000 2020Z0
250 x 250	4,65 DS00 2525S0	7,15 DS00 2525E0	7,15 DS00 2525I0	16,00 DS00 2525Z0	6,05 D000 2525S0	9,90 D000 2525E0	9,90 D000 2525I0	23,70 D000 2525Z0
300 x 300	4,65 DS00 3030S0	7,15 DS00 3030E0	7,15 DS00 3030I0	16,00 DS00 3030Z0	6,05 D000 3030S0	9,90 D000 3030E0	9,90 D000 3030I0	23,70 D000 3030Z0
350 x 350	6,35 DS00 3535S0	9,75 DS00 3535E0	9,75 DS00 3535I0	21,80 DS00 3535Z0	8,20 D000 3535S0	13,50 D000 3535E0	13,50 D000 3535I0	32,30 D000 3535Z0
400 x 400	8,30 DS00 4040S0	12,70 DS00 4040E0	12,70 DS00 4040I0	28,50 DS00 4040Z0	10,80 D000 4040S0	17,60 D000 4040E0	17,60 D000 4040I0	42,20 D000 4040Z0
450 x 450	10,50 DS00 4545S0	16,10 DS00 4545E0	16,10 DS00 4545I0	36,00 DS00 4545Z0	13,60 D000 4545S0	22,30 D000 4545E0	22,30 D000 4545I0	53,40 D000 4545Z0
500 x 500	13,00 DS00 5050S0	19,90 DS00 5050E0	19,90 DS00 5050I0	44,50 DS00 5050Z0	16,80 D000 5050S0	27,50 D000 5050E0	27,50 D000 5050I0	65,90 D000 5050Z0
Andere Größen: Preise auf Anfrage								

Piktogramm „Vogel“

schwarz (nicht reflektierend), mit Übertragungsfolie. Schützt Vögel und Glasscheiben (z. B. von Bushaltestellen).

Ausführung 1:



Flügelspannweite ca. 500 mm, (Höhe ca. 290 mm)	DS51 2850S0	8,50
Flügelspannweite ca. 350 mm, (Höhe ca. 240 mm)	DS51 2035S0	5,00

Ausführung 2:



Flügelspannweite ca. 240 mm, (Höhe ca. 150 mm)	DS52 1524S0	4,00
------------------------------------------------	-------------	------

Andere Größen: Preise auf Anfrage

FOLIENSCHILDER,
SELBSTKLEBENDE, REFLEKTIERENDE



Größe in mm	Folie RA1 (.193 00 **01)	Folie RA2 (.193 00 **0P)	Folie RA3 (.193 00 **03)	Größe in mm	Folie RA1 (.193 00 **01)	Folie RA2 (.193 00 **0P)	Folie RA3 (.193 00 **03)
Dreiecke				Rechtecke			
SL 630	14,00	26,00	34,40	231 x 420	8,70	15,80	20,10
SL 900	26,10	50,60	67,10	330 x 600	15,80	29,60	38,60
SL 1260	48,30	97,40	128,60	412 x 750	24,60	45,80	60,20
				315 x 420	12,40	21,30	27,40
Ronden:				450 x 600	20,90	40,40	53,80
Ø 420	11,60	22,00	29,00	562 x 750	31,20	61,30	80,30
Ø 600	21,50	41,30	54,10	630 x 420	21,70	39,70	52,20
Ø 750	32,50	64,40	84,10	900 x 600	42,10	77,80	102,90
				1260 x 840	82,60	152,70	222,50
Pfeilwegweiser				250 x 1000	19,80	35,40	48,50
250 x 1000	19,80	37,40	48,50	300 x 800	18,60	37,00	47,10
333 x 1250	31,80	62,20	80,60	300 x 1000	25,50	47,80	64,50
350 x 1400	36,80	73,30	94,90	500 x 1000	39,50	74,80	96,90
				500 x 1500	56,30	109,80	143,80
				650 x 1000	51,30	97,20	125,90
				750 x 500	27,50	54,30	72,20
Achtecke:							
900 x 900	57,10	116,20	151,10				
1050 x 1050	77,50	157,80	205,20	Quadrate			
				420 x 420	14,50	28,00	35,60
				500 x 500	19,10	37,30	48,90
				600 x 600	26,80	52,80	70,90
				750 x 750	40,20	80,40	107,10
				840 x 840	53,40	104,80	132,10

In der Liste nicht aufgeführte Größen und Ausführungsarten können auf Kundenwunsch gefertigt werden.

Breite in mm	Reflexfolie RA 1A				Reflexfolie RA 2C		Reflexfolie RA 3C	
	weiß	gelb	blau	rot	weiß	gelb	weiß	gelb
	Rolle: 50,0 m lang							
1235	1267,50	-	-	-	2271,00	-	4241,40	-
	FR10112350				FR20112250C		FR30112350C	
1020	1046,90	-	-	-	1875,60	-	3480,70	-
	FR10110150				FR20110150C		FR30110150C	
920	944,20	944,20	944,20	-	1691,70	1691,70	3139,50	3139,50
	FR10109150	FR10209150	FR10809150		FR20109250C	FR20209250C	FR30109250C	FR30209250C
760	780,00	780,00	-	780,00	1397,50	1397,50	2593,50	-
	FR10107650	FR10207650		FR10407650	FR20107650C	FR20207650C	FR30107650C	
610	626,10	-	-	-	1121,70	-	2081,70	-
	FR10106150				FR20106150C		FR30106150C	
	laufende Meter							
1235	28,00	-	-	-	50,00	-	92,80	-
	FR10112301				FR20112201C		FR30112301C	
1020	23,10	-	-	-	41,30	-	76,60	-
	FR10110101				FR20110101C		FR30110101C	
920	20,80	20,80	20,80	-	37,30	37,30	69,10	69,10
	FR10109101	FR10209101	FR10809101		FR20109201C	FR20209201C	FR30109201C	FR30209201C
760	17,20	17,20	-	17,20	30,80	30,80	57,10	-
	FR10107601	FR10207601		FR10407601	FR20107601C	FR20207601C	FR30107601C	
610	13,80	-	-	-	24,70	-	45,90	-
	FR10106101				FR20106101C		FR30106101C	

Breite in mm	Letteringfilm	Magnetfolie 0,8 mm stark
	schwarz	weiß matt
	Rolle: 50,0 m lang	Rolle: 10,0 m lang
1220	636,50	-
	FRL0912250	
1000	-	468,70
		FM08 10010
	laufende Meter	
1220	14,10	-
	FRL0912201	
1000	-	51,60
		FM08 10001